ARES-1983H Series

**Compact Embedded Computer with
Intel® 12th/13th Gen. Core™ i7/i5/i3 Processor**

User's Manual

Version 1.0

Revision History

Version	Date	Description
1.0	2023.09	Initial release

Revision History	ii
Contents	i
Preface.....	iii
Copyright Notice	iii
Declaration of Conformity	iii
CE.....	iii
FCC Class A	iii
RoHS	iv
SVHC / REACH	iv
Important Safety Instructions	v
Warning.....	vi
Lithium Battery Replacement.....	vi
Technical Support	vi
Warranty.....	vii
Chapter 1 - Introduction.....	1
1.1. Features.....	2
1.2. About this Manual	2
1.3. Specifications.....	3
1.4. Inside the Package	5
Chapter 2 - Getting Started.....	7
2.1. Dimensions	8
2.2. Overview	9
2.2.1. Front View (ARES-1983-MV).....	9
2.2.2. LED Indicator Status.....	10
2.3. Driver Installation Note	11
Chapter 3 - Engine of the Computer.....	13
3.1. Main Board - FMB-i93Q0	14
3.1.1. Jumper & Connectors	15
3.1.2. Jumper & Connectors Settings.....	16
3.2. Daughter Board - SCDB-348D (For ARES-1983H-MV).....	20
3.2.1. Connectors Settings	21
Chapter 4 - Installation and Maintenance.....	23
4.1. Disassembling and Assembling the Computer	24
4.1.1 Disassembling the Computer (ARES-1983H).....	24
4.1.2. Disassembling the Computer (ARES-1983H-MV).....	25
4.1.3. Assembling the Computer.....	26
4.2. Installing Hardware	27
4.2.1. Installing CPU	27
4.2.2. Installing Memory Module.....	28
4.2.3. Installing a 2.5" SSD or HDD	30

4.2.4. Installing a M.2 Module.....	31
4.2.5. Installing WI-FI connection module and antenna.....	33
4.2.6. Installing a SIM Card and relative connection module.....	36
4.3. Mounting	38
4.3.1. Wall Mounting	38
4.3.2. DIN-Rail Mounting	39
Chapter 5 - BIOS	41
5.1. Main	44
5.2. Advanced	45
5.2.1. CPU Configuration.....	46
5.2.2. Power & Performance.....	47
5.2.3. PCH-FW Configuration	50
5.2.4. Trusted Computing	51
5.2.5. ACPI Settings.....	53
5.2.6. F81966 Super IO Configuration.....	54
5.2.7. Hardware Monitor	56
5.2.8. S5 RTC Wake Settings	57
5.2.9. Serial Port Console Redirection.....	58
5.2.10. AMI.....	59
5.2.11. USB Configuration	60
5.2.12. Network Stack Configuration	62
5.2.13. NVMe Configuration	63
5.3. Chipset.....	64
5.3.1. System Agent (SA) Configuration	65
5.3.2. PCH-IO Configuration.....	70
5.4. Security	73
5.4.1 Security Boot	74
5.5. Boot.....	75
5.6. Save & Exit	76
Appendix	77
Appendix A. 16-bit Opto-Isolated DI Signal Connections.....	78
A.1. Wet Contact DI with NPN / PNP connection	78
A.2. Dry Contact DI with NPN / PNP connection	79
Appendix B. 16-bit Opto-Isolated DO Signal Connections	80
B.1. DO Connection diagram.....	80

Copyright Notice

All Rights Reserved.

The information in this document is subject to change without prior notice in order to improve the reliability, design and function. It does not represent a commitment on the part of the manufacturer.

Under no circumstances will the manufacturer be liable for any direct, indirect, special, incidental, or consequential damages arising from the use or inability to use the product or documentation, even if advised of the possibility of such damages.

This document contains proprietary information protected by copyright. All rights are reserved. No part of this document may be reproduced by any mechanical, electronic, or other means in any form without prior written permission of the manufacturer.

Declaration of Conformity

CE

The CE symbol on your product indicates that it is in compliance with the directives of the Union European (EU). A Certificate of Compliance is available by contacting Technical Support.

This product has passed the CE test for environmental specifications when shielded cables are used for external wiring. We recommend the use of shielded cables. This kind of cable is available from ARBOR. Please contact your local supplier for ordering information.

Warning

This is a class A product. In a domestic environment this product may cause radio interference in which case the user may be required to take adequate measures.

FCC Class A

This device complies with Part 15 of the FCC Rules. Operation is subject to the following two conditions:

- (1) This device may not cause harmful interference, and
- (2) This device must accept any interference received, including interference that may cause undesired operation.

NOTE:

This equipment has been tested and found to comply with the limits for a Class A digital device, pursuant to Part 15 of the FCC Rules. These limits are designed to provide reasonable protection against harmful interference when the equipment is operated in a commercial environment. This equipment generates, uses, and can radiate radio frequency energy and, if not installed and used in accordance with the instruction manual, may cause harmful interference to radio communications. Operation of this equipment in a residential area is likely to cause harmful interference in which case the user will be required to correct the interference at his own expense.

RoHS

ARBOR Technology Corp. certifies that all components in its products are in compliance and conform to the European Union's Restriction of Use of Hazardous Substances in Electrical and Electronic Equipment (RoHS) Directive 2002/95/EC.

The above mentioned directive was published on 2/13/2003. The main purpose of the directive is to prohibit the use of lead, mercury, cadmium, hexavalent chromium, polybrominated biphenyls (PBB), and polybrominated diphenyl ethers (PBDE) in electrical and electronic products. Member states of the EU are to enforce by 7/1/2006.

ARBOR Technology Corp. hereby states that the listed products do not contain unintentional additions of lead, mercury, hex chrome, PBB or PBDB that exceed a maximum concentration value of 0.1% by weight or for cadmium exceed 0.01% by weight, per homogenous material. Homogenous material is defined as a substance or mixture of substances with uniform composition (such as solders, resins, plating, etc.). Lead-free solder is used for all terminations (Sn(96-96.5%), Ag(3.0-3.5%) and Cu(0.5%)).

SVHC / REACH

To minimize the environmental impact and take more responsibility to the earth we live, Arbor hereby confirms all products comply with the restriction of SVHC (Substances of Very High Concern) in (EC) 1907/2006 (REACH --Registration, Evaluation, Authorization, and Restriction of Chemicals) regulated by the European Union.

All substances listed in SVHC < 0.1 % by weight (1000 ppm)

Important Safety Instructions

Read these safety instructions carefully

1. Read all cautions and warnings on the equipment.
2. Place this equipment on a reliable surface when installing. Dropping it or letting it fall may cause damage
3. Make sure the correct voltage is connected to the equipment.
4. For pluggable equipment, the socket outlet should be near the equipment and should be easily accessible.
5. Keep this equipment away from humidity.
6. The openings on the enclosure are for air convection and protect the equipment from overheating. **DO NOT COVER THE OPENINGS.**
7. Position the power cord so that people cannot step on it. Do not place anything over the power cord.
8. Never pour any liquid into opening. This may cause fire or electrical shock.
9. Never open the equipment. For safety reasons, the equipment should be opened only by qualified service personnel.
10. If one of the following situations arises, get the equipment checked by service personnel:
 - a. The power cord or plug is damaged.
 - b. Liquid has penetrated into the equipment.
 - c. The equipment has been exposed to moisture.
 - d. The equipment does not work well, or you cannot get it to work according to the user's manual.
 - e. The equipment has been dropped or damaged.
 - f. The equipment has obvious signs of breakage.
11. Keep this User's Manual for later reference.

Warning

The Box PC and its components contain very delicately Integrated Circuits (IC). To protect the Box PC and its components against damage caused by static electricity, you should always follow the precautions below when handling it:

1. Disconnect your Box PC from the power source when you want to work on the inside.
2. Use a grounded wrist strap when handling computer components.
3. Place components on a grounded antistatic pad or on the bag that came with the Box PC, whenever components are separated from the system.

Lithium Battery Replacement

Incorrect replacement of the lithium battery may lead to a risk of explosion.

The lithium battery must be replaced with an identical battery or a battery type recommended by the manufacturer.

Do not throw lithium batteries into the trash can. It must be disposed of in accordance with local regulations concerning special waste.

Technical Support

If you have any technical difficulties, please consult the user's manual first at: <https://www.arbor-technology.com>

Please do not hesitate to call or e-mail our customer service when you still cannot find out the answer.

<https://www.arbor-technology.com>

E-mail: info@arbor.com.tw

Warranty

This product is warranted to be in good working order for a period of one year from the date of purchase. Should this product fail to be in good working order at any time during this period, we will, at our option, replace or repair it at no additional charge except as set forth in the following terms. This warranty does not apply to products damaged by misuse, modifications, accident or disaster.

Vendor assumes no liability for any damages, lost profits, lost savings or any other incidental or consequential damage resulting from the use, misuse of, or inability to use this product. Vendor will not be liable for any claim made by any other related party.

Vendors disclaim all other warranties, either expressed or implied, including but not limited to implied warranties of merchantability and fitness for a particular purpose, with respect to the hardware, the accompanying product's manual(s) and written materials, and any accompanying hardware. This limited warranty gives you specific legal rights.

Return authorization must be obtained from the vendor before returned merchandise will be accepted. Authorization can be obtained by calling or faxing the vendor and requesting a Return Merchandise Authorization (RMA) number. Returned goods should always be accompanied by a clear problem description.

This page is intentionally left blank.

Chapter 1

Introduction

1.1. Features



- Socket LGA1700 for Intel® 12th/13th Core™ i7/i5/i3 Processor
- Fansink Design - Active Cooling without internal Dust Accumulation
- Modular Design - Easily expandable and customizable
- Support up to 6 x USB & 7 x LAN(4 w/ PoE)
- Dual-Display for 1 x VGA and 1 x DisplayPort
- DI/DO with 1.5KV Isolation Protection, DI supports Connection of Dry & Wet Contact Devices
- M.2 2242/2280 M-Key Slot support SATA & NVMe(Gen4 x4)
- 2 x Internal USB 2.0 Type-A ports for HW License Key & Security Dongle

1.2. About this Manual

This manual is meant for the experienced users and integrators with hardware knowledge of personal computers. If you are not sure about the description in this manual, consult your vendor before further handling.

We recommend that you keep one copy of this manual for the quick reference for any necessary maintenance in the future. Thank you for choosing ARBOR products.

The ARES-1983H series includes the following models:

	Outlook	Description
ARES-1983H		ARES-1983 w/ H610E Chipset, 3 x LAN, 2 x COM, 6 x USB, 1 x DP, 1 x VGA, 1 x M.2 E-Key, 1 x mPCIe & 1 x M.2 M-Key
ARES-1983H-MV		ARES-1983H w/ 4 x GbE PoE, 16 x isolated DI + 16 x isolated DO & 1 x 2.5" SSD/HDD tray

1.3. Specifications

System	
CPU	Intel® 12th/13th Core™ i7/i5/i3 processor in LGA1700 Socket (Max.65W)
Memory	1 x 262-pin DDR5 SO-DIMM sockets, supporting 5600MHz SDRAM up to 32GB
Chipset	Intel® H610E
Graphics	Integrated Intel® UHD Graphics 730/770
LAN Chipset	1 x Intel® i226LM 1 x Intel® i219LM 5 x Intel® i210AT (4 x for GbE PoE)
Watchdog Timer	1~255 levels reset
TPM	dTPM 2.0
I/O	
Serial Port	1 x RS232 _(Default) /422/485 1 x RS232
USB Port	2 x USB-A 3.2 Gen2 (10Gbps) 2 x USB-A 3.2 Gen1 (5Gbps) 2 x USB-A 2.0 2 x internal USB-A 2.0
LAN	1 x 2.5GbE ports 2 x GbE ports 4 x GbE PoE ports(IEEE802.3af) (For ARES-1983H-MV)
Video Port	1 x DisplayPort 1.4, up to 4096x2304@60Hz 1 x VGA, up to 1920x1200@60Hz
Digital I/O	16 x DI & 16 x DO w/ 1.5kV isolation (For ARES-1983H-MV)
Expansion Bus	1 x M.2 E-key 2230 slot (PCIe 3.0 x1 + USB2.0 + CNVi) 1 x mPCIe (PCIe 3.0 x1 + USB 2.0, Full size) w/ 1 x nano SIM card slot
Others	4 x Antenna holes

Storage	
Type	1 x M.2 M-key 2242/2280 slot (PCIe 4.0 x4 + SATA)
	1 x 2.5" HDD/SSD internal drive bay (For ARES-1983H-MV)
Environmental	
Operating Temp.	w/ 35W TDP CPU: -20 ~ 60°C, ambient w/ air flow w/ 65W TDP CPU: -20 ~ 50°C, ambient w/ air flow
Storage Temp.	-30 ~ 70°C
Operating Humidity	10-95% @ 60°C (non-condensing)
Vibration	5~500Hz 3 Grms X,Y,Z axis w/SSD, according to IEC 68-2-64
Shock	10G peak acceleration (11 m sec. duration), operation
	30G peak acceleration (11 m sec. duration), nonoperation
	According to IEC 68-2-27
Qualification	
Certification	CE, FCC Class A
Power Requirement	
Power Input	DC 12~24V via 2-pin terminal block
Max. Power Consumption	ARES-1983H (w/ 65W TDP CPU): 110W ARES-1983H-MV(w/ 65W TDP CPU): 170W
Mechanical	
Construction	Metal + Aluminum
Mounting	Wall-mount (standard) DIN-rail (optional w/ CTOS bracket)
Weight	ARES-1983H: 2.5kg ARES-1983H-MV: 3.1kg
Dimensions (W x D x H)	ARES-1983H: 55 x 164 x 210mm ARES-1983H-MV: 90 x 164 x 210mm
OS Support	
Windows 10 / Windows 11 / Ubuntu	

1.4. Inside the Package

Upon opening the package, carefully inspect the contents. If any of the items is missing or appears damaged, contact your local dealer or distributor. The package should contain the following items:



1 x ARES-1983H / ARES-1983H-MV

ARES-1983H

1 x Accessory Box that contains the following items:

- User's manual
- 2 x 2-pin terminal block plug
- 6 x M3*4L screws (for wall mount bracket)
- 1 x Wall mounting bracket (Pair)
- 1 x Thermal grease



ARES-1983H-MV

- User's manual
- 2 x 2-pin terminal block plug
- 2 x 19-pin terminal block plug
- 8 x M3 4mm screws (for 2.5" drive & tray)
- 6 x M3*4L screws (for wall mount bracket)
- 1 x Wall mounting bracket (Pair)
- 1 x 2.5" HDD/SSD bracket
- 1 x Thermal grease

This page is intentionally left blank.

Chapter 2

Getting Started

2.1. Dimensions

ARES-1983H

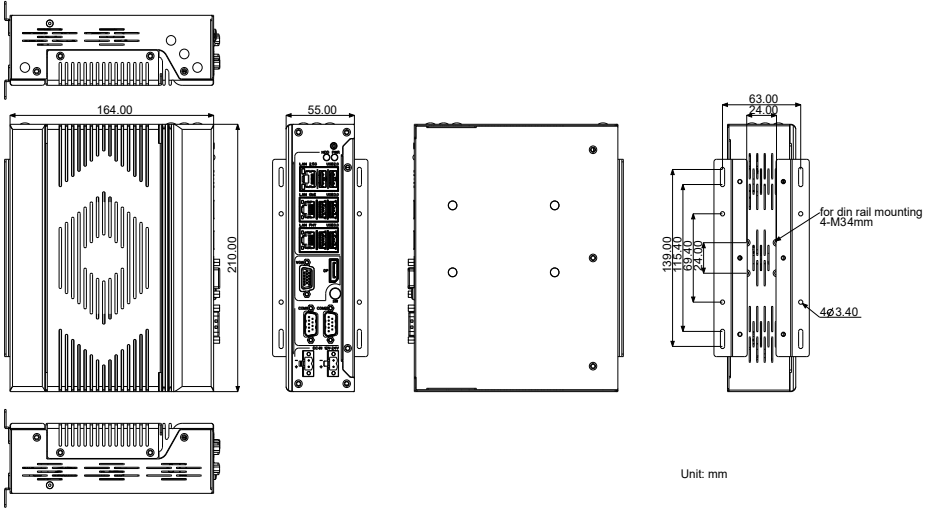

ARES-1983H-MV

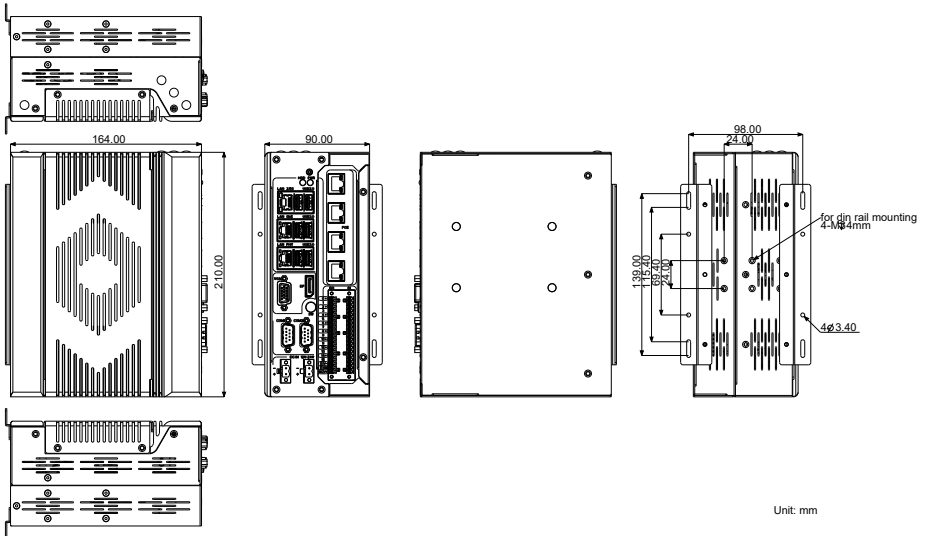

2.2. Overview

2.2.1. Front View (ARES-1983-MV)

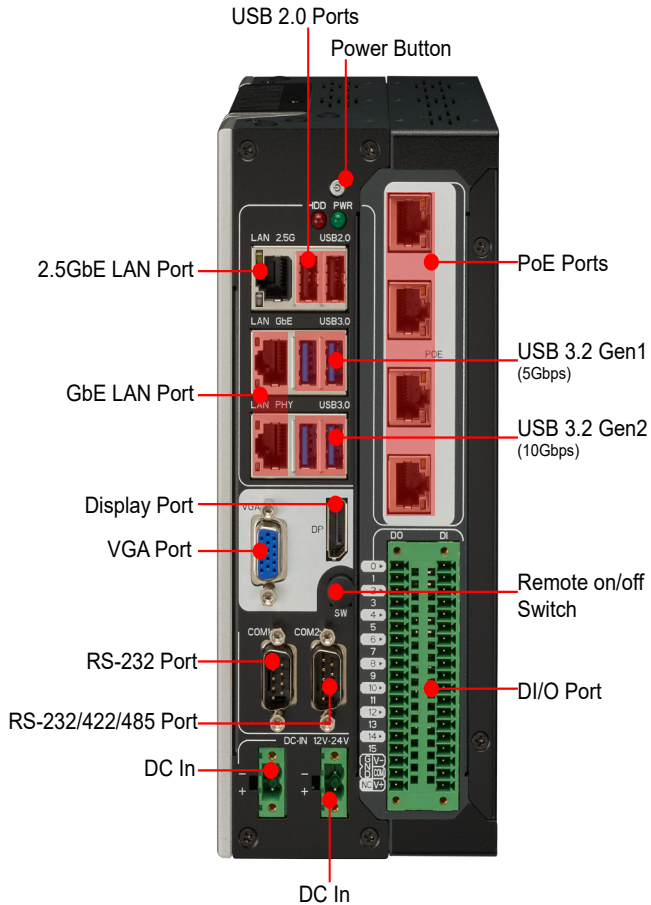

DC In Connector

Connector Type: 2.54mm pitch 2-pin terminal Block

Pin Assignment: Pin Description

1 DC in (+)

2 Ground (-)

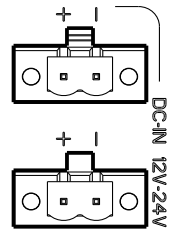

Note: Please note that one DC in is enough to power up the device. Select either one for DC input and the other one could be output to provide additional power.

COM Connector

Connector Type: 9-pin D-sub Male Connector

Pin Assignment:

	RS-232	RS-422	RS-485
Pin	Signal name		
1	DCD	COM_422 TX-	COM_485 D-
2	RXD	COM_422 TX+	COM_485 D+
3	TXD	COM_422 RX+	
4	DTR	COM_422 RX-	
5	GND	GND	GND
6	DSR		
7	RTS		
8	CTS		
9	RI		

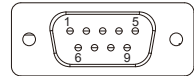

2.2.2. LED Indicator Status

LED Indicator	Color	Description
PWR Button	Green	Solid: The system is in operation(S0)
	Red	Solid: The system is in in sleep/hibernate mode(S3/S4) or power off mode(S5)
PWR LED	Solid Green	Solid: The system is powered on
SATA HDD/SSD	Red	Flashing: Data is transmitting
GbE LAN	Yellow	Solid: Link is established Flashing: Data is transmitting
	Green/Orange	Orange: 1 Gbit/s connection Green: 100 Mbit/s connection Off: 10 Mbit/s connection
2.5GbE LAN	Yellow	Solid: Link is established Flashing: Data is transmitting
	Green/Orange	Orange: 2.5 Gbit/s connection Green: 1 Gbit/s connection Off: 10/100 Mbit/s connection

2.3. Driver Installation Note

For operating system of Windows 10, please go to our website at **www.arbor-technology.com** and download the driver pack from the product page. Then unzip the downloaded file and follow the sequence below to install the drivers to prevent errors:

Chipset → Other drivers

The driver path is listed as below:

Windows 10

Driver	Path
Chipset	\\WIN10\Chipset\SetupChipset.exe
Graphics	\\WIN10\Graphics\win64\Installer.exe
Intel ME	\\WIN10\ME\Main_DCH\SetupME.exe
Intel Serial IO	\\WIN10\Intel Serial IO\SetupSerialIO.exe
LAN	\\WIN10\LAN\Wired_driver_27.7_x64\Wired_driver_27.7_x64.exe

Chapter 3

Engine of the Computer

3.1. Main Board - FMB-i93Q0

Top:

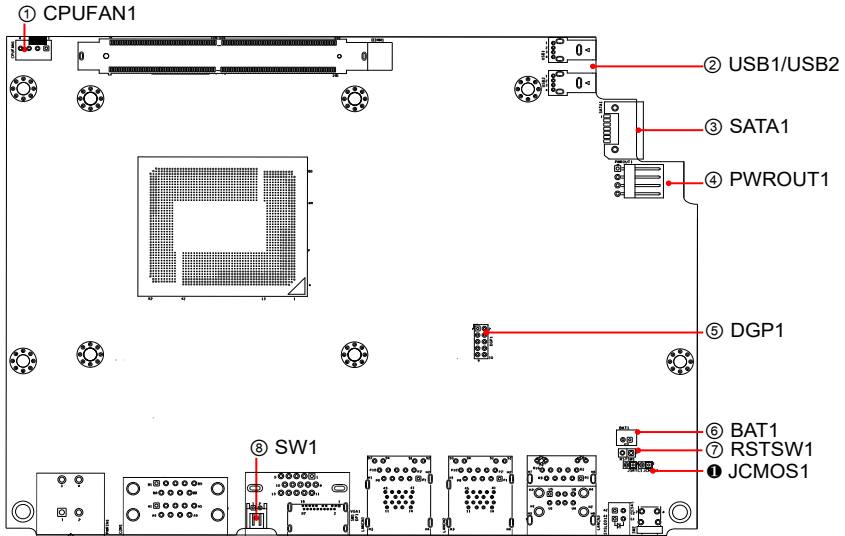

Bottom:

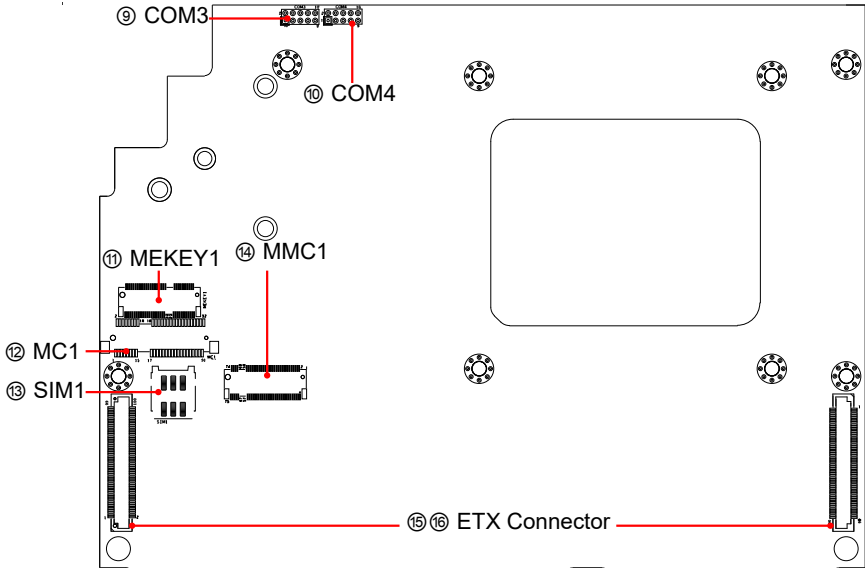

3.1.1. Jumper & Connectors

Jumper

Label	Description
❶ JCMOS1	Clear CMOS Jumper

Connectors

Label	Description
❶ CPUFAN1	System Fan Connector
❷ USB1/USB2	USB 2.0 Type-A Connector
❸ SATA1	SATA 7-pin Connector
❹ PWROUT1	SATA Power Connector
❺ DGP1	Debug Port
❻ BAT1	RTC Battery Connector
❼ RSTSW1	Reset Button (Reserved for OEM products)
❽ SW1	Remote Control
❾ COM3	RS-232/RS-422/RS-485 Serial Port Header (Reserved for OEM products)
❿ COM4	RS-232 Serial Port Header (Reserved for OEM products)
⓫ MEKEY1	M.2 E-Key Socket
⓬ MC1	Mini PCI-e Socket
⓭ SIM1	Nano SIM Card Socket
⓮ MMC1	M.2 M-Key Socket
⓯ ^⓰ ETX Connector	Daughter Board Connector

3.1.2. Jumper & Connectors Settings

① JCMOS1

Function: Clear CMOS Selection

Jumper Type: 2.00mm pitch 2-pin Header

Setting: **Cond. Description**

Short	Clear CMOS	
Open	Keep CMOS (default)	

① CPUFAN1

Function: Fan Power Connector

Connector Type: 2.54mm pitch 4-pin Wafer

Pin Assignment: **Pin Description**

1	GND
2	+12V
3	RPM
4	Control



② USB1/USB2

Function: USB 2.0 Type-A Connector

Connector Type: USB 2.0 Type-A Connector

Pin Assignment: The pin assignment conform to the industry standard.

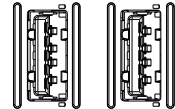

③ SATA1

Function: SATA 7-pin Connector

Connector Type: Standard 7-pin Serial ATA Connector

Pin Assignment: **Pin Description Pin Description**

1	GND	2	TX+
3	TX-	4	GND
5	RX-	6	RX+
7	GND		



④ PWROUT1

Function: SATA Power Connector

Connector Type: 2.54mm pitch 4-pin Wafer

Pin Assignment:	Pin	Description
	1	+5V
	2	GND
	3	GND
	4	+12V



⑤ DGP1

Function: Debug Port

Connector Type: 2.00mm pitch 10-pin Header

Pin Assignment:	Pin	Description	Pin	Description
	1	ESPI_CLK	2	GND
	3	ESPI_CS0#	4	ESPI_IO0
	5	ESPI_RST#	6	V3.3A
	7	ESPI_IO3	8	ESPI_IO2
	9	V3.3S	10	ESPI_IO1

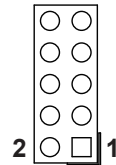

⑥ BAT1

Function: RTC Battery Connector

Connector Type: 2-pin Box Header

Pin Assignment:	Pin	Description
	1	BAT+
	2	BAT-



⑦ RSTSW1

Function: Reset Button

Connector Type: 2-pin Header

Pin Assignment:	Pin	Description
	1	FR_RST#
	2	GND



⑧ **SW1**

Function: Remote Control

Connector Type: 2-pin Header(S2B-PH-K-S)

Pin Assignment:

Pin	Description
1	PWR_IN_SW#
2	GND



⑨ **COM3**

Function: RS-232/RS-422/RS-485 Serial Port Header

Connector Type: 2.00mm pitch 9-pin Header

Pin Assignment:

Pin	RS-232	RS-422	RS-485
1	DCD	COM_422 TX-	COM_485 D-
2	RXD	COM_422 TX+	COM_485 D+
3	TXD	COM_422 RX+	
4	DTR	COM_422 RX-	
5	GND	GND	GND
6	DSR		
7	RTS		
8	CTS		
9	RI		



⑩ **COM4**

Function: RS232 Serial Port Header

Connector Type: 2.00mm pitch 9-pin Header

Pin Assignment:

Pin	Description	Pin	Description
1	DCD	2	RXD
3	TXD	4	DTR
5	GND	6	DSR
7	RTS	8	CTS
9	RI		



⑪ **MEKEY1**

Function: M.2 E-Key Socket (w/ PCIe 3.0 x1 + USB 2.0) for Wi-Fi/BT

Connector Type: M.2 E-Key 2230 Socket

Pin Assignment: The pin assignments conform to the industry standard.

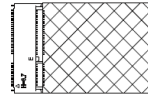

⑫ **MC1**

Function: Full-size mini PCI-e Socket (w/ PCIe 3.0 x1 + USB 2.0)

Connector Type: Mini PCI-e 52-pin Socket

Pin Assignment: The pin assignments conform to the industry standard.

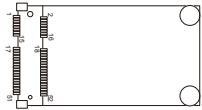

⑬ **SIM1**

Function: Nano SIM Card Socket

Connector Type: Nano SIM Card Socket

Pin Assignment: The pin assignments conform to the industry standard.

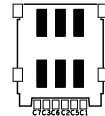

⑭ **MMC1**

Function: M.2 M-Key Socket (w/ PCIe 4.0 x4 + SATA) for storage or expansion module

Connector Type: M.2 M-Key 2242/2280 Socket

Pin Assignment: The pin assignments conform to the industry standard.



⑮⑯ **ETX Connector**

Function: Daughter Board Connector

Connector Type: 100-pin Connector

Pin Assignment: ARBOR original design pin out

For requirement of customized daughter board, please contact ARBOR.

3.2. Daughter Board - SCDB-348D (For ARES-1983H-MV)

Function: PoE and isolated digital I/O daughter board

Applicable models: ARES-1983H-MV

Top:

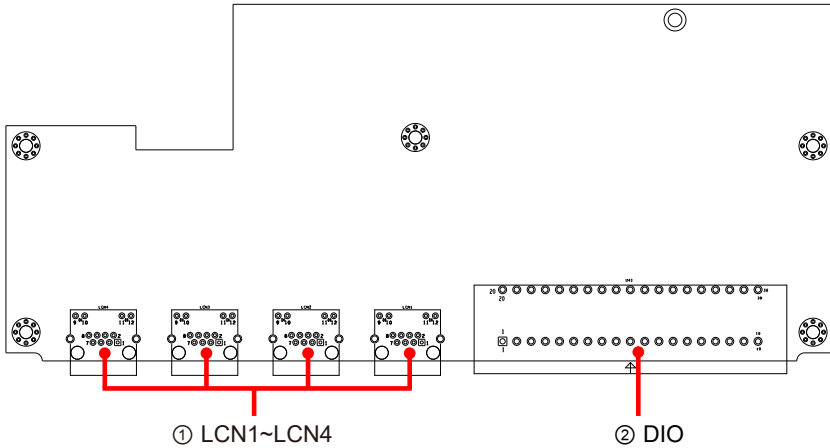

Bottom

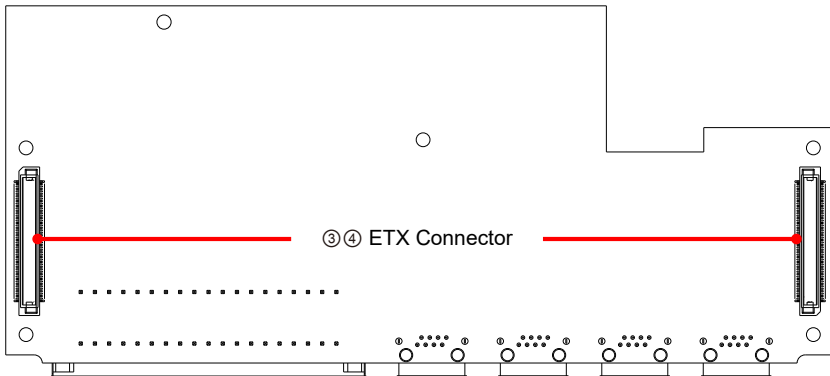

3.2.1. Connectors Settings

① LCN1~LCN4

Function: 1GbE PoE (IEEE 802.3af)

Connector Type: RJ-45 Connector

Pin Assignment: The pin assignments conform to the industry standard.



② DIO

Function: Digital Input & Output

Connector Type: 38-pin Terminal Block

Pin Assignment:

Pin	Description	Pin	Description
1	DOUT_00	20	DIN_00
2	DOUT_01	21	DIN_01
3	DOUT_02	22	DIN_02
4	DOUT_03	23	DIN_03
5	DOUT_04	24	DIN_04
6	DOUT_05	25	DIN_05
7	DOUT_06	26	DIN_06
8	DOUT_07	27	DIN_07
9	DOUT_08	28	DIN_08
10	DOUT_09	29	DIN_09
11	DOUT_10	30	DIN_10
12	DOUT_11	31	DIN_11
13	DOUT_12	32	DIN_12
14	DOUT_13	33	DIN_13
15	DOUT_14	34	DIN_14
16	DOUT_15	35	DIN_15
17	GND_ISO	36	GND_24V_ISO
18	GND_ISO	37	COM1
19	NC	38	+24V_IS

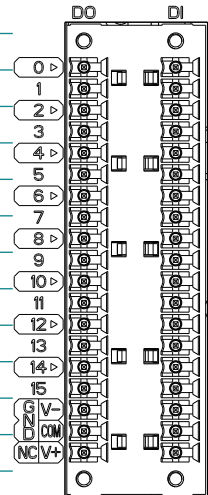

③④ ETX Connector

Function: Daughter Board Connector

Connector Type: 100-pin Connector

Pin Assignment: ARBOR original design pin out

For requirement of customized daughter board, please contact ARBOR.

This page is intentionally left blank.

Chapter 4

Installation & Maintenance

4.1. Disassembling and Assembling the Computer

4.1.1 Disassembling the Computer (ARES-1983H)

To use onboard jumpers/connectors or to install/remove internal components, you will need to open the computer to access the inside of the computer. Follow through the guide below to disassemble the computer.

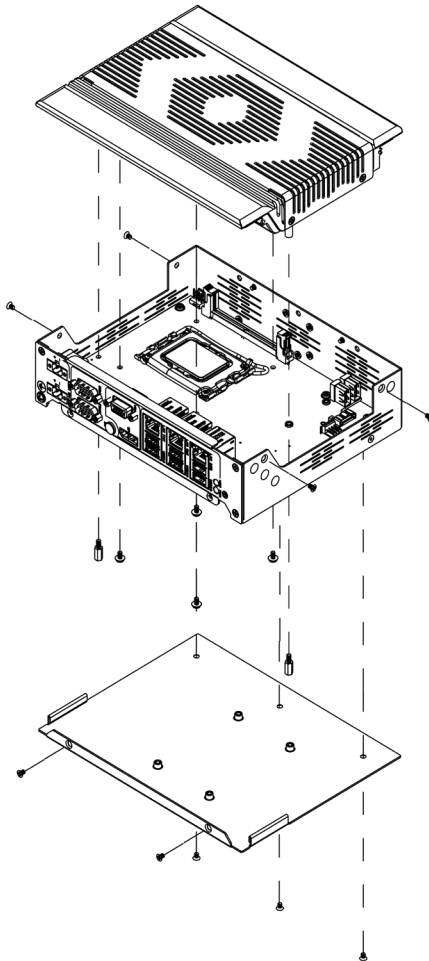

4.1.2. Disassembling the Computer (ARES-1983H-MV)

To use onboard jumpers/connectors or to install/remove internal components, you will need to open the computer to access the inside of the computer. Follow through the guide below to disassemble the computer.

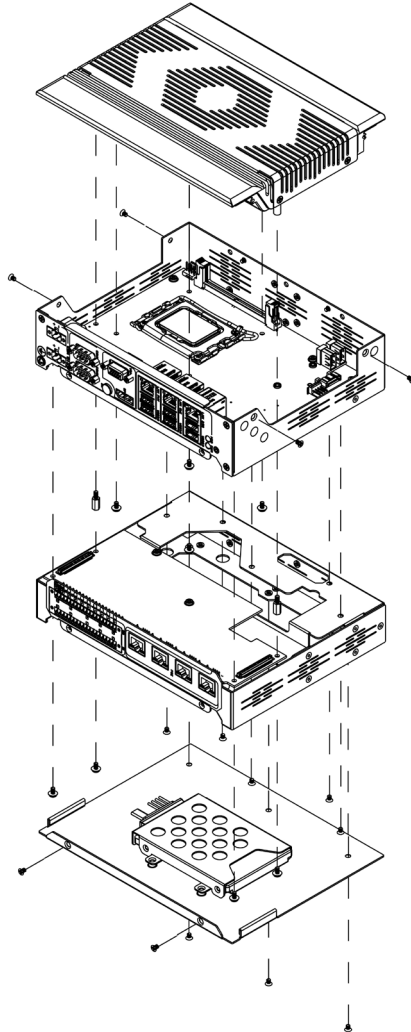

Bottom side of the main board

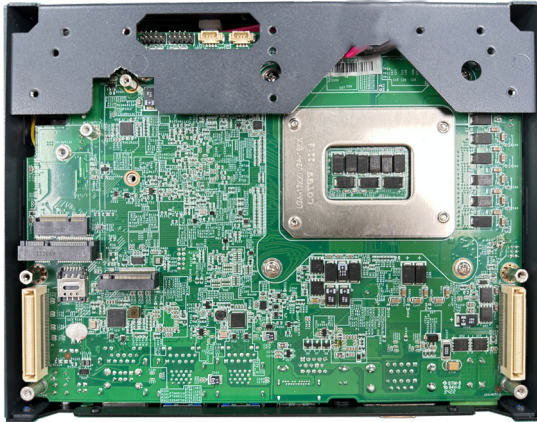

Top side of the main board

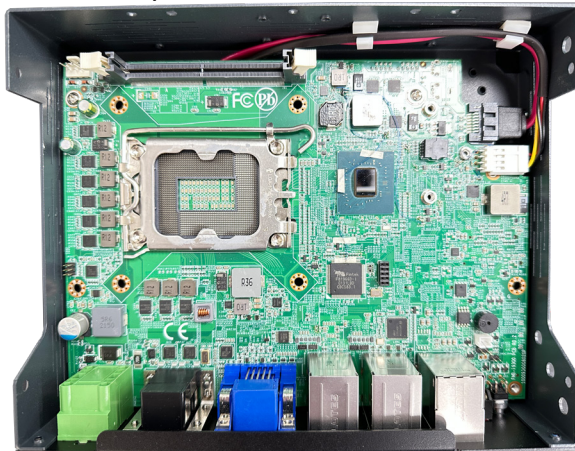

4.1.3. Assembling the Computer

After completing the required hardware installation and jumpers settings, assemble the computer as above figure.

4.2. Installing Hardware

4.2.1. Installing CPU

1. Remove the top and side cover from the computer as described in [4.1. Disassembling and Assembling the Computer on page 24](#)
2. Locate the CPU socket on the main board
The processor socket comes with a mylar sticker to secure the processor.
Please refer to the pictures step by step as below and note that the cover of the socket must always be installed during transportation to avoid damage to the socket.

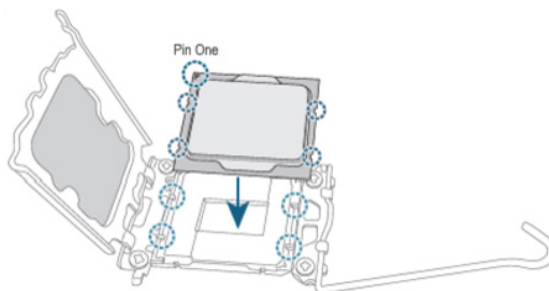
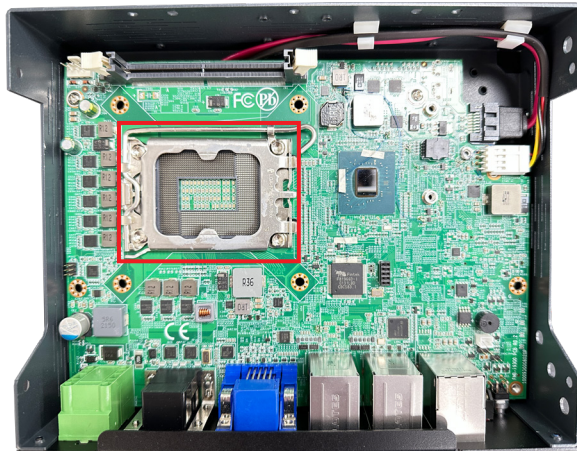

4.2.2. Installing Memory Module

1. Remove the top cover from the computer as described in [4.1. Disassembling and Assembling the Computer on page 24](#)
2. Locate the SO-DIMM sockets on the main board.

The SO-DIMM sockets are vertical type, and each socket has two latches for fixing the memory modules. The memory module can only be installed by one direction due to the notch.

3. Pull back both latches from the socket.

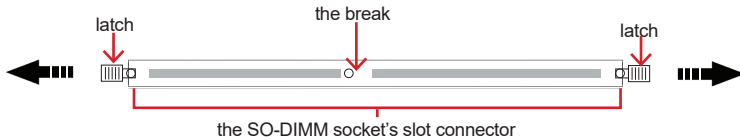

vertical-type SO-DIMM socket (overview)

4. Confront the memory module's golden finger at the SO-DIMM socket. Position the memory module at the SO-DIMM socket, with the memory module's key notch aligned at the break of the SO-DIMM's slot connector.
5. Locate memory module sockets.

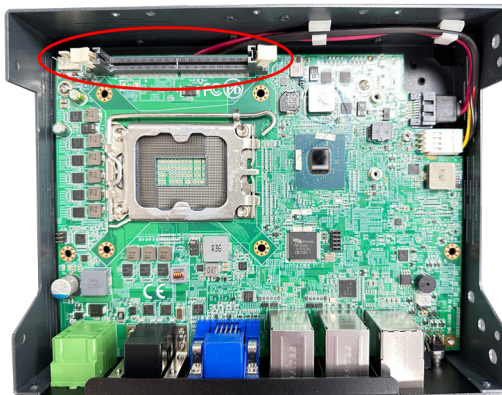

6. Align the notch on the memory module with the key in the module socket.



7. Vertically plug the memory module to the DIMM socket. “Fully” plug the memory module until both latches auto-lock the memory module in place.

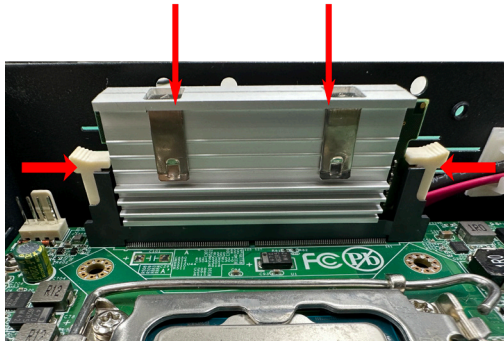

4.2.3. Installing a 2.5" SSD or HDD

1. Remove the bottom cover from the computer as described in [4.1.2. Disassembling the Computer \(ARES-1983H-MV\) on page 25.](#)
2. Using 4 x M3*4 screws coming with the storage device kit to install a 2.5" HDD or SSD storage device into the drive bay.

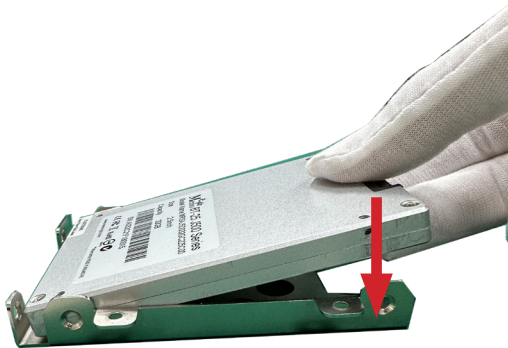

3. Using the other 4 x M3*4 screws to fix the drive bay to the bottom cover.

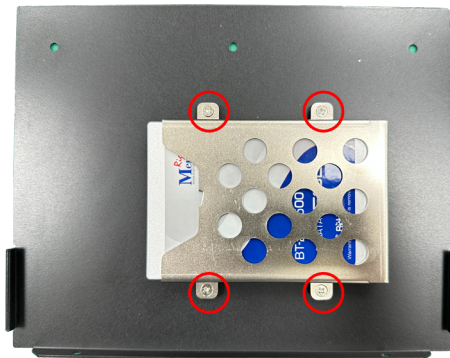

4. Connect the cables assembled inside to the SATA drive.
5. Close the cover.

Note: Only **ARES-1983H-MV** is available to install 2.5" HDD or SSD storage device.

4.2.4. Installing a M.2 Module

The computer has a M.2 M-Key socket for NVMe or SATA SSD. This section will use a 22 x 80 form factor as the installation example.

1. Remove the bottom cover from the computer as described in [4.1. Disassembling and Assembling the Computer on page 24](#). Then locate the M.2 on-board connector.

ARES-1983H

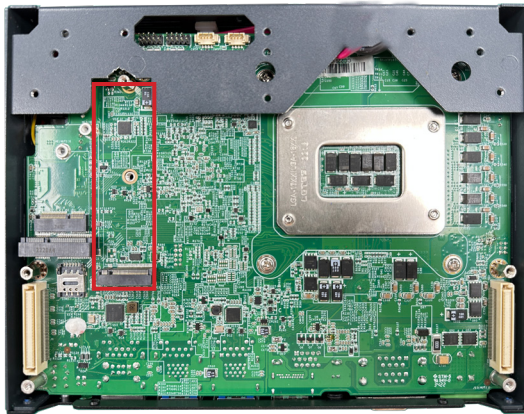

ARES-1983H-MV

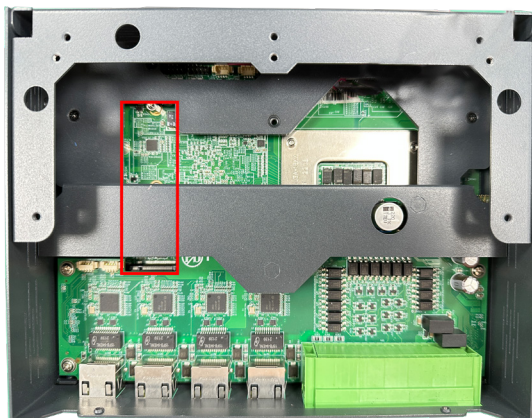

2. Insert the M.2 module into the socket by aligning the notch on the module with the small slot on the M.2 socket.



3. Insert and fasten the screw into the standoff.

4.2.5. Installing WI-FI connection module and antenna

1. Remove the bottom cover from the computer as described in [4.1.2. Disassembling the Computer \(ARES-1983H-MV\)](#) on page 25.
2. Locate the **M.2 E-Key** socket for wireless module.

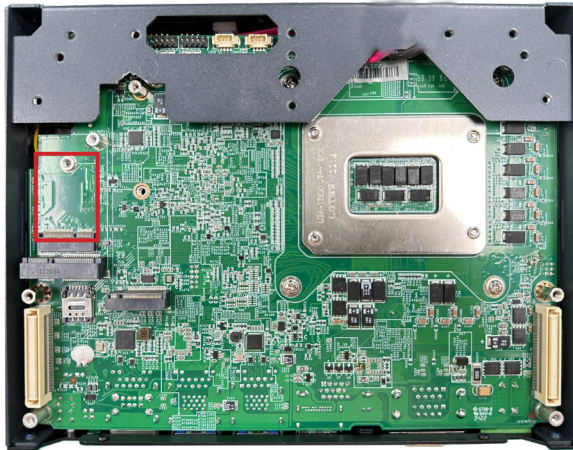

3. Prepare the Wi-Fi module kit. The module is a **M.2 E-Key** socket form factor, with two MHF connectors, one is “MAIN”, and the other is “AUX”.

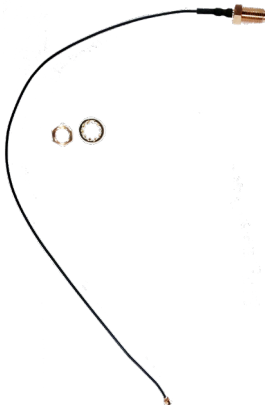

Two MHF connectors, one is “MAIN” (marked 2), the other is “AUX” (marked 1).



4. Have the RF antenna. The antenna has an SMA connector on one end and an MHF connector on the other.

- Connect the RF antenna's MHF connector to the Wi-Fi module's main connector marked 0. If you are going to connect a secondary antenna, connect it to the connector marked 2

Connect the RF antenna's MHF connector to the Wi-Fi module's main connector (marked 2)

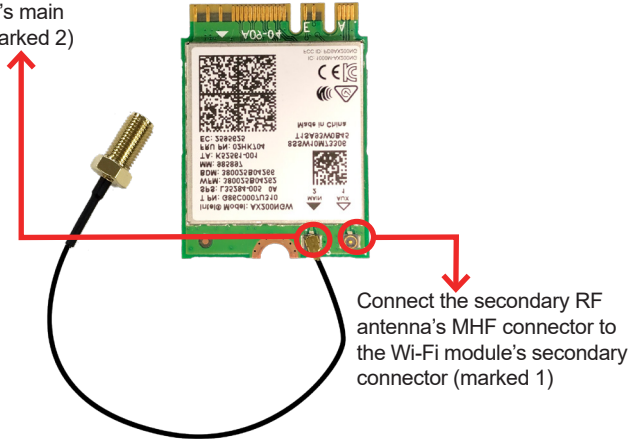

- Plug the Wi-Fi module to the socket's connector by a slanted angle. Fully plug the module, and note that the notch on the wireless module should meet the break of the connector, then fasten the screw.



- Locate the SMA antenna holes and. Remove the plastic plug(s) from the computer's top panel side to make antenna hole(s). Keep the plastic plug for any possible restoration in the future.

- From the other end of the RF antenna, which is an SMA connector, remove the washer and the nut. Note the SMA connector has the form of a threaded bolt, with one flat side.



- Pull the SMA connector through the above mentioned antenna hole. Note to meet the aforesaid flattened side with the antenna hole's flat side.

Arrange the flat side of the SMA connector to meet the flat side of the antenna hole.

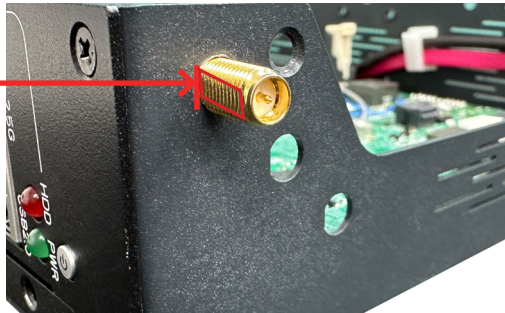

- Mount the washer first and then the nut to the SMA connector. Make sure the nut is tightened.

Mount the washer and the nut to the SMA connector. Tighten the nut.

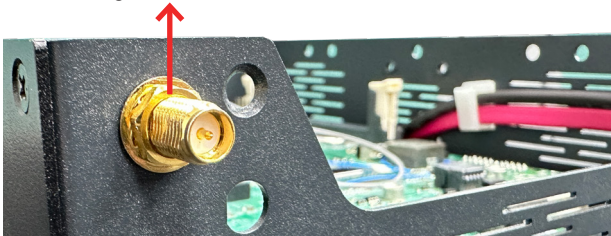

- After completing the required hardware installation, assemble the computer by performing the proceeding steps in reverse order.

4.2.6. Installing a SIM Card and relative connection module

This section will guide you how to install a SIM card and relative connection module.

1. Remove the bottom cover from the computer as described in [4.1.2. Disassembling the Computer \(ARES-1983H-MV\) on page 25.](#)
2. Locate the SIM card slot on the main board.

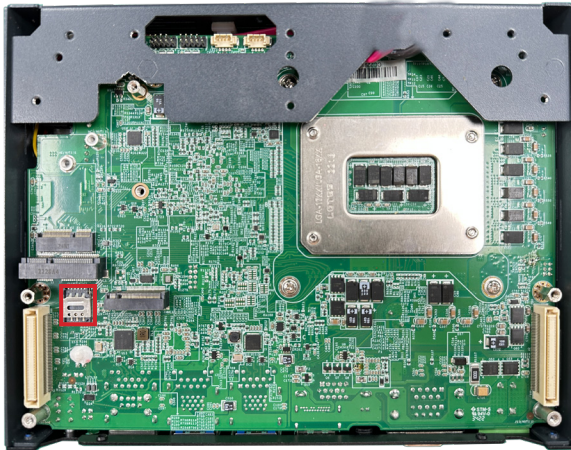

3. Slide the SIM card holder cover towards the OPEN edge and then lift the cover to open it.

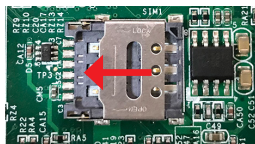

4. Insert the SIM card into the card holder as shown below.

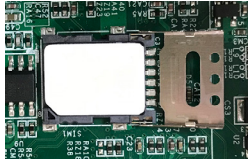

5. Close the SIM card holder door and slide the door to the LOCK edge to lock into place.

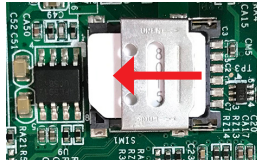

6. Locate the MC1 slot and insert the relative communication module then fasten the screw.

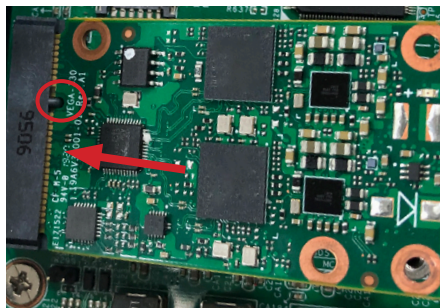
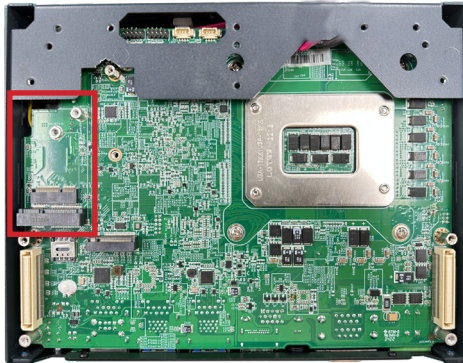

4.3. Mounting

4.3.1. Wall Mounting

To wall mount the computer using the provided wall-mount kit:

1. Select a proper mounting location with adequate wall strength to support the mounted unit.
2. Locate the 6 screw holes on the computer's rear side. Use the screws (M3x4L, qty:6) included in the wall-mount kit to assemble the brackets to the computer's rear side.
3. Use the other screw holes and cutouts on both wall-mount brackets to mount the computer to a wall.

- **ARES-1983H**

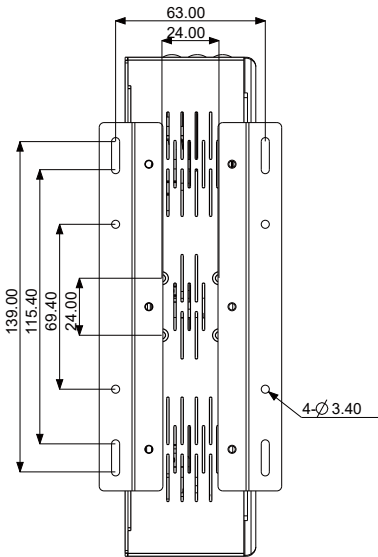

- **ARES-1983H-MV**

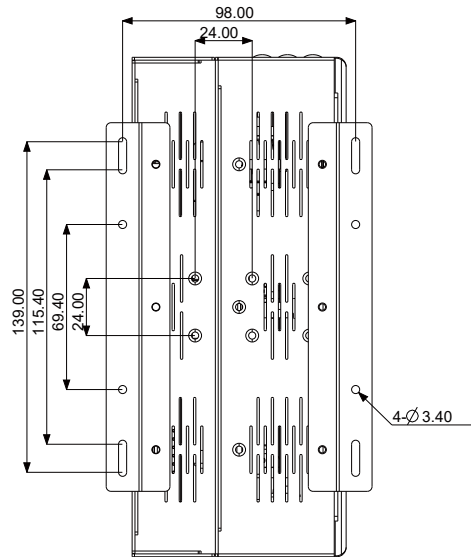

4.3.2. DIN-Rail Mounting

To mount the computer using the optional DIN-rail mounting kit:

1. Select a proper mounting location with adequate wall strength to support the mounted unit.
2. Screw the DIN-rail mounting clip with included screws (M3x5mm, qty:4) to the rear side of the computer as below.

- **ARES-1983H**

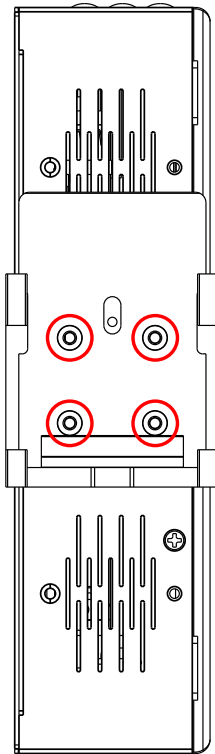

- **ARES-1983H-MV**

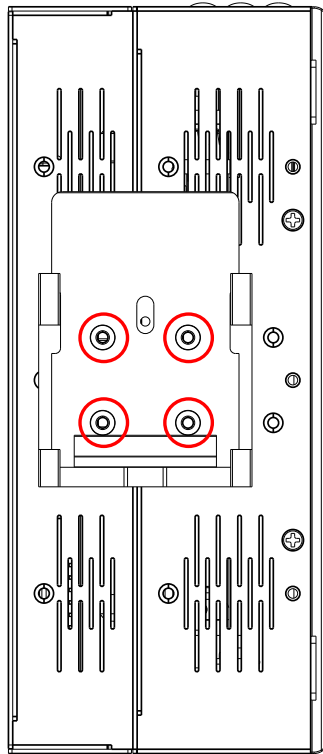

After you screw the DIN-rail mounting clip to the computer:

1. Snap the DIN Rail clip to the lower edge of the DIN Rail.
2. Press the computer firmly upward towards the DIN Rail until the DIN Rail clip tab engages and snaps to the upper edge of the DIN Rail.

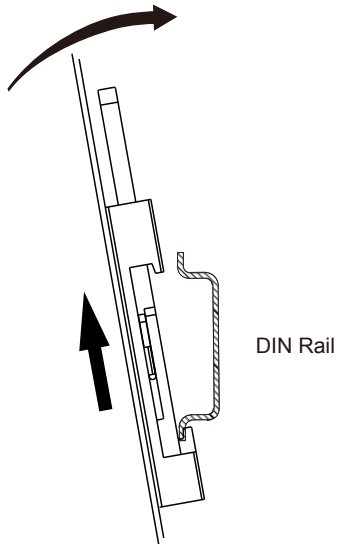

Chapter 5

BIOS

BIOS

The BIOS Setup utility is featured by American Megatrends Inc to configure the system settings stored in the system's BIOS ROM. The BIOS is activated once the computer powers on. When the computer is off, the battery on the main board supplies power to BIOS RAM.

To enter the BIOS Setup utility, keep hitting the “Delete” key upon powering on the computer.

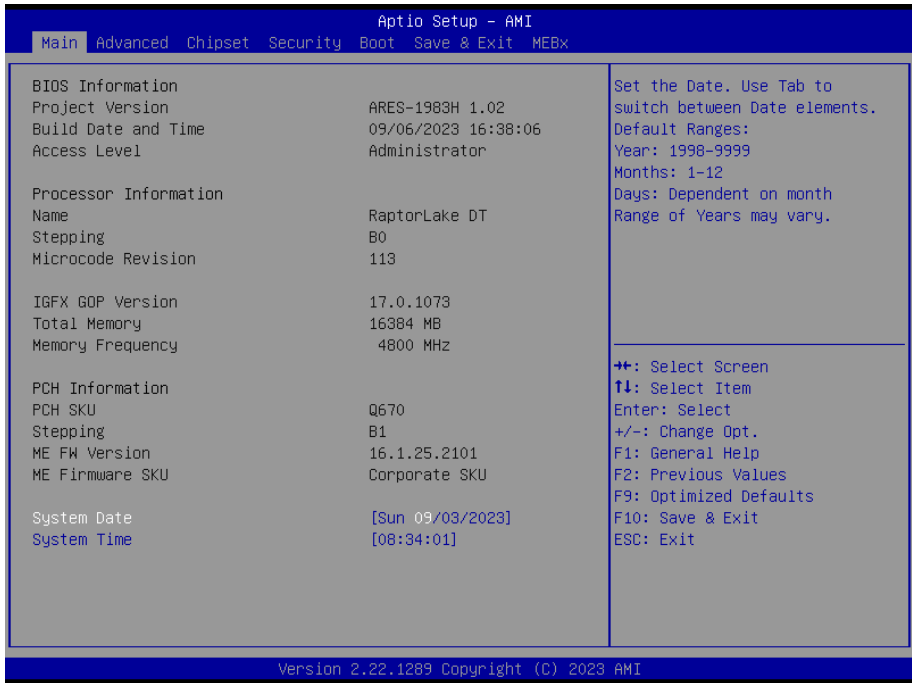

Note: Actual model name and board information varies according to your model.

Menu	Description
Main	See 5.1. Main on page 44
Advanced	See 5.2. Advanced on page 45
Chipset	See 5.3. Chipset on page 64
Security	See 5.4. Security on page 73
Boot	See 5.5. Boot on page 75
Save & Exit	See 5.6. Save & Exit on page 76

Key Commands

The BIOS Setup utility relies on a keyboard to receive user's instructions. Hit the following keys to navigate within the utility and use the utility.

Keystroke	Function
← →	Moves left/right between the top menus.
↓ ↑	Moves up/down between highlight items.
Enter	Selects an highlighted item/field.
Esc	<ul style="list-style-type: none"> ▶ On the top menus: Use Esc to quit the utility without saving changes to CMOS. (The screen will prompt a message asking you to select OK or Cancel to exit discarding changes. ▶ On the submenus: Use Esc to quit current screen and return to the top menu.
Page Up / +	Increases current value to the next higher value or switches between available options.
Page Down / -	Decreases current value to the next lower value or switches between available options.
F1	Opens the Help of the BIOS Setup utility.
F10	Exits the utility saving the changes that have been made. (The screen then prompts a message asking you to select OK or Cancel to exit saving changes.)

Note: Pay attention to the "WARNING" that shows at the left pane onscreen when making any change to the BIOS settings.

This BIOS Setup utility is updated from time to time to improve system performance and hence the screenshots hereinafter may not fully comply with what you actually have onscreen.

5.1. Main

The **Main** menu features the settings of **System Date** and **System Time** and displays some BIOS info.

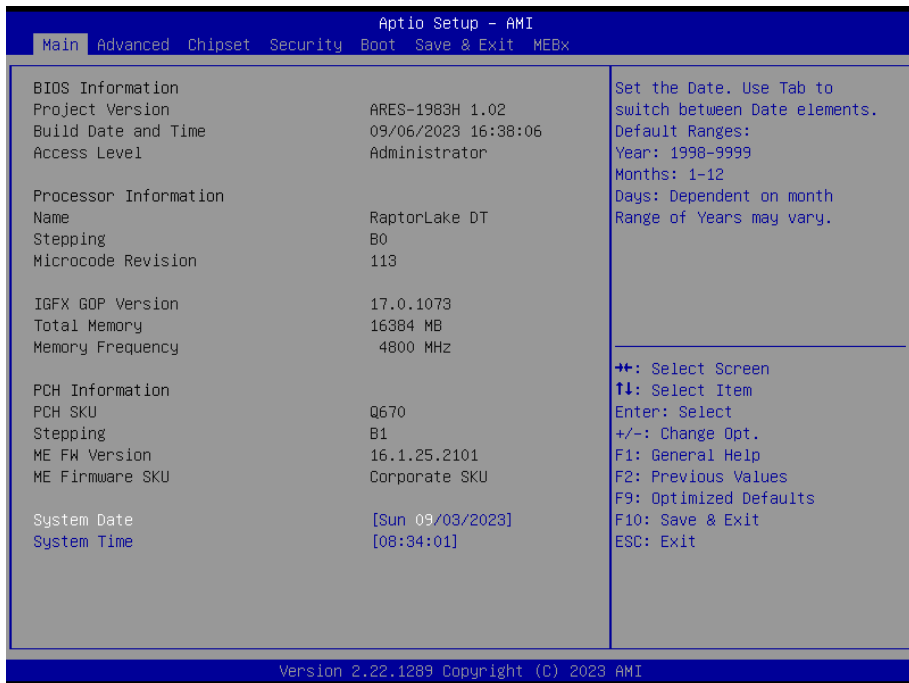

Note: Actual model name and board information varies according to your model.

Setting	Description
Project Version	Delivers the model name of the computer and BIOS version.
Build Date and Time	Delivers the date and time when the BIOS Setup utility was made/ updated.
Access Level	Delivers the level that the BIOS is being accessed at the moment.
System Date	Sets system date.
System Time	Sets system time.

5.2. Advanced

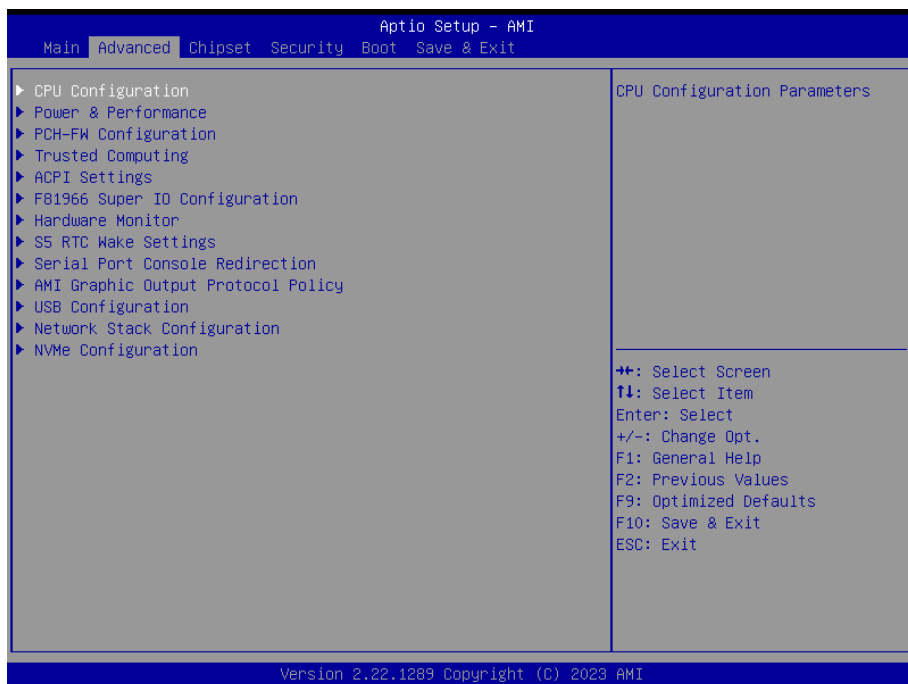

Setting	Description
CPU Configuration	See 5.2.1. CPU Configuration on page 46
Power & Performance	See 5.2.2. Power & Performance on page 47
PCH-FW Configuration	See 5.2.3. PCH-FW Configuration on page 50
Trusted Computing	See 5.2.4. Trusted Computing on page 51
ACPI Settings	See 5.2.5. ACPI Settings on page 53
F81966 Super IO Configuration	See 5.2.6. F81966 Super IO Configuration on page 54
Hardware Monitor	See 5.2.7. Hardware Monitor on page 56
S5 RTC Wake Settings	See 5.2.8. S5 RTC Wake Settings on page 57
Serial Port Console Redirection	See 5.2.9. Serial Port Console Redirection on page 58
AMI Graphic Output Protocol Policy	See 5.2.10. AMI on page 59
USB Configuration	See 5.2.11. USB Configuration on page 60
Network Stack Configuration	See 5.2.12. Network Stack Configuration on page 62
NVMe Configuration	See 5.2.13. NVMe Configuration on page 63

5.2.1. CPU Configuration

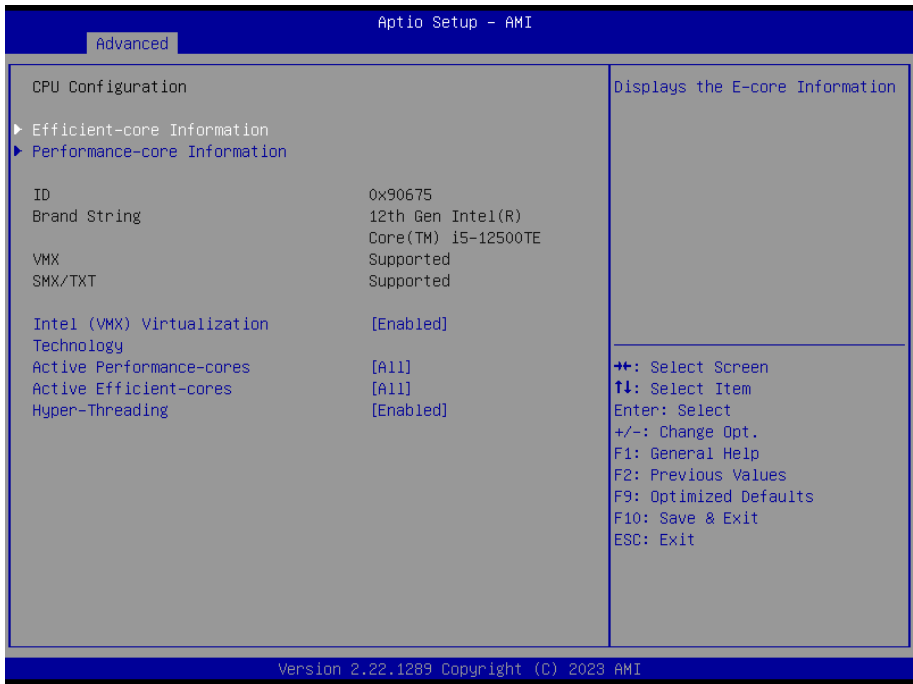

Setting	Description
Efficient-core Information	Display the E-core Information
Performance-core Information	Display the P-core information
Intel (VMX) Virtualization Technology	When enabled, a VMM can utilize the additional hardware capabilities provided by Vanderpool Technology ► Options: Enabled (default) or Disabled
Active Processor-Cores	Number of cores to enable in each processor package. ► Options: All (default), 1 , 2 and 3 .
Active Efficient-Cores	Number of cores to enable in each processor package.
Hyper-Threading	This item is used to enable or disable the processor's Hyper-threading feature. Enabled for Windows XP and Linux (OS optimized for Hyper-threading Technology) and disabled for other OS (OS not optimized for Hyper-threading Technology). When disabled, only one thread per enabled core is enabled. ► Options: Enabled (default) or Disabled * This setting may not be available depending on the CPU.

5.2.2. Power & Performance

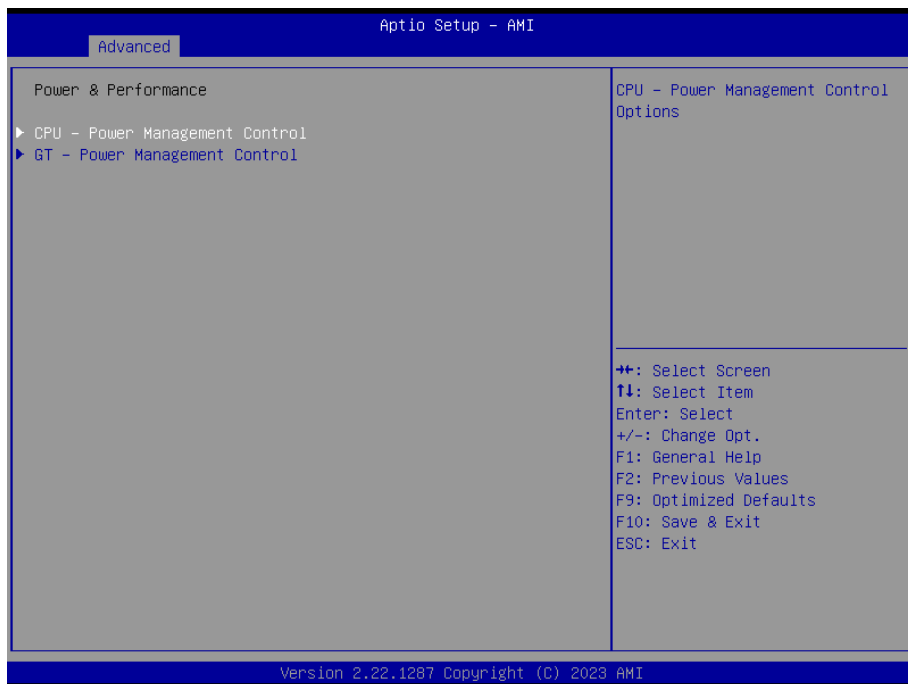

Setting	Description
CPU - Power Management Control	Configure CPU Power Management See 5.2.2.1. CPU - Power Management Control on page 48
GT - Power Management Control	Configure graphics processors Power Management See 5.2.2.2. GT - Power Management Control on page 49

5.2.2.1. CPU - Power Management Control

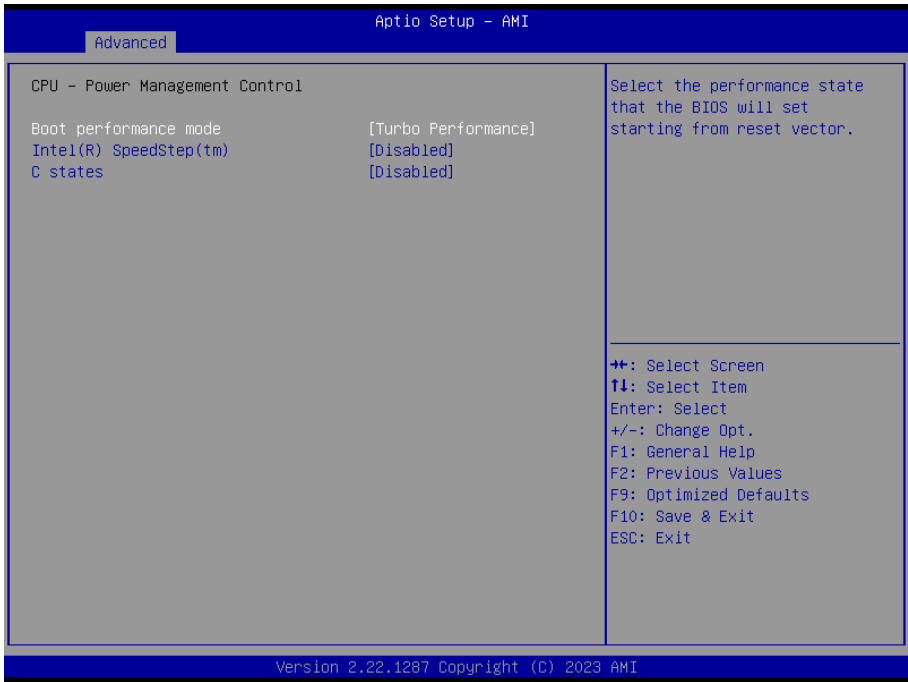

Setting	Description
Boot performance Mode	Set the performance state that the BIOS will set before the OS handoff. ► Options: Max Non-Turbo Performance (default), Max Battery and Turbo Performance
Intel (R) Speed Step (tm)	Enable (default) / Disable Intel SpeedStep
C States	Enable / Disable (default) CPU C States

5.2.2.2. GT - Power Management Control

Aptio Setup - AMI

Advanced

GT - Power Management Control RC6(Render Standby) [Enabled] Maximum GT frequency [Default Max Frequency] Disable Turbo GT frequency [Disabled]	Check to enable render standby support. ⇧⇩: Select Screen ↑↓: Select Item Enter: Select +/-: Change Opt. F1: General Help F2: Previous Values F9: Optimized Defaults F10: Save & Exit ESC: Exit
---	--

Version 2.22.1287 Copyright (C) 2023 AMI

Setting	Description
RC6 (Render Standby)	Function of activation and deactivation the energy-saving mechanism integrated into the Intel graphics core processors when the computer enters sleep mode. Enable (default) / Disable
Maximum GT frequency	This item maximum GT frequency limited by te user. Value beyond the range will be clipped to min/max supported by SKU. Default Max Frequency (default)
Disable Turbo GT frequency	This item Disable Turbo GT frequency. Enabled : Disables Turbo GT frequency. Disabled : GT frequency is no limited. Disabled (Default) / Enabled

5.2.3. PCH-FW Configuration

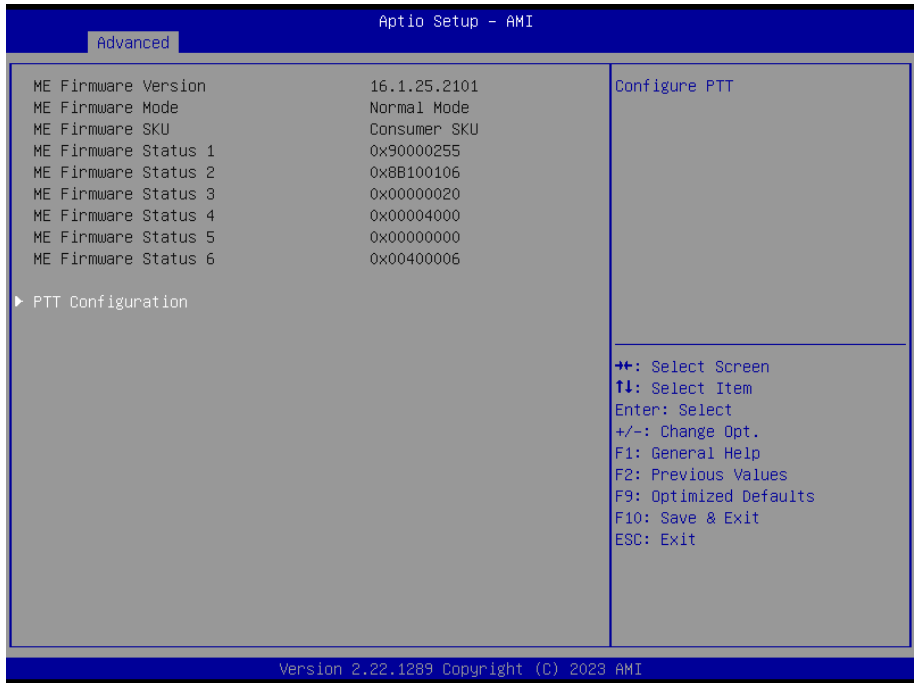

Setting	Description
PTT Configuration	Select TPM device: PTT or dPTM. PTT - Enables PTT in SKuMgr dTPM1.2 - Disables PTT in SKuMgr Warning! PTT/dTPM will be disabled and all data saved on it will be lost. Options: dTPM (default) / PTT

5.2.4. Trusted Computing

Aptio Setup - AMI

Advanced

TPM 2.0 Device Found	7.63	Enables or Disables BIOS support for security device. O.S. will not show Security Device. TCG EFI protocol and INT1A interface will not be available.
Firmware Version:	IFX	
Security Device Support	[Enabled]	
Active PCR banks	SHA256	
Available PCR banks	SHA256	
SHA256 PCR Bank	[Enabled]	
Pending operation	[None]	
Platform Hierarchy	[Enabled]	
Storage Hierarchy	[Enabled]	
Endorsement Hierarchy	[Enabled]	
Physical Presence Spec Version	[1.3]	↑↓: Select Screen ↑↓: Select Item Enter: Select +/-: Change Opt. F1: General Help F2: Previous Values F9: Optimized Defaults F10: Save & Exit ESC: Exit
TPM 2.0 InterfaceType	[TIS]	
Device Select	[Auto]	

Version 2.22.1287 Copyright (C) 2023 AMI

Setting	Description
Security Device Support	This item enables or disables BIOS support for security device. OS will not show Security Device. Enabled (Default) / Disabled
SHA256 PCR Bank	Enables or disables SHA-1 PCR Bank. Enabled (Default) / Disabled
Pending operation	This item schedule an operation for the security device. None (Default) / TPM Clear
Platform Hierarchy	Enables or disables Platform Hierarchy Enabled (Default) / Disabled
Storage Hierarchy	Enables or disables Storage Hierarchy Enabled (Default) / Disabled
Endorsement Hierarchy	Enables or disables Endorsement Hierarchy. Enabled (Default) / Disabled

Physical Presence Spec Version	This item select to tell O.S. to support PPI Spec Version 1.2 or 1.3. Options are: 1.3 (Default) / 1.2
Device Select	TPM 1.2 will restrict support to TPM 1.2 devices, TPM 2.0 will restrict support to TPM 2.0 devices, Auto will support both TPM 2.0 devices and TPM 1.2 devices. Options are: Auto (Default)/ TPM 1.2/TPM 2.0

5.2.5. ACPI Settings

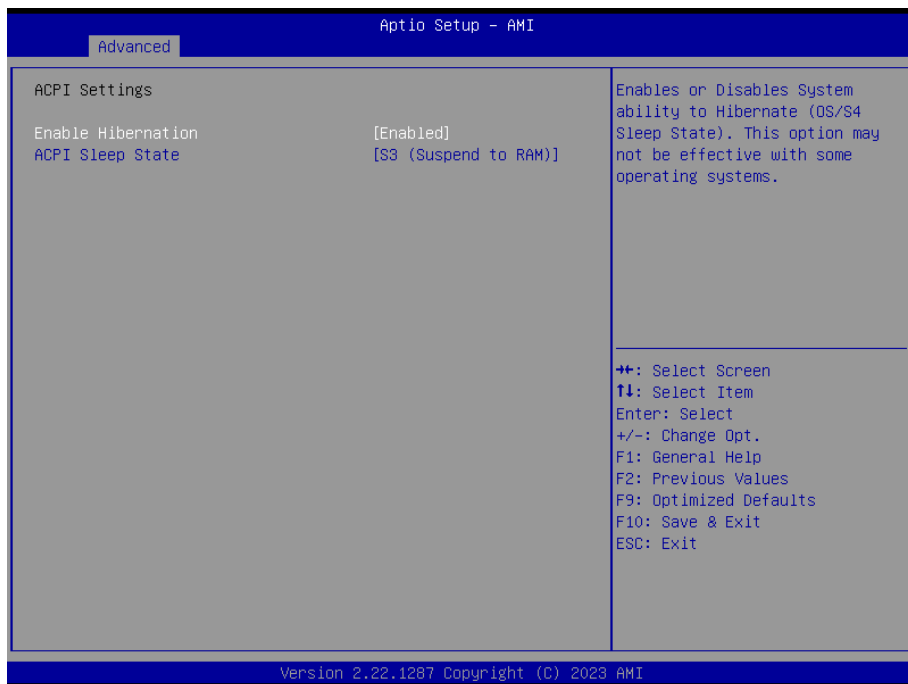

Setting	Description
Enable Hibernation	Enable (default) or Disable system ability to Hibernate (OS/ S4 Sleep State). This option may not be effective with some operating system.
ACPI Sleep State	Only available when BIOS ACPI Auto Configuration is enabled. Select ACPI sleep state the system will enter when the SUSPEND button is pressed. ► Options: Suspend Disabled and S3 (Suspend to RAM) (default)

5.2.6. F81966 Super IO Configuration

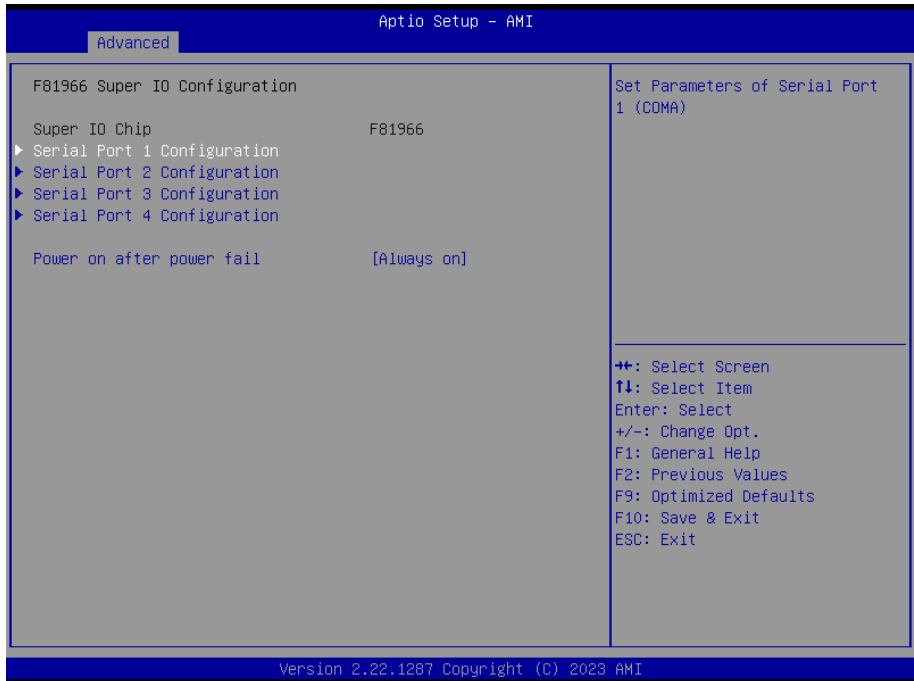

Note: The quantity of serial ports varies according to your model.

Setting	Description
Serial Port 1/2/3/4 Configuration	<p>To configure each COM port settings.</p> <p>Serial Port 1:</p> <ul style="list-style-type: none"> ▶ Options: Enable and Disable Serial Port (COM) (default) <p>Serial Port2:</p> <ul style="list-style-type: none"> ▶ Options: Enable and Disable Serial Port (COM) (default) ▶ Options: Mode Select for RS-232 (default) RS-422, RS-422(Termination Resistor), RS-485, RS-485(Termination Resistor) <p>Serial Port3:</p> <ul style="list-style-type: none"> ▶ Options: Enable and Disable Serial Port (COM) (default) ▶ Options: Mode Select for RS-232 (default) RS-422, RS-422(Termination Resistor), RS-485, RS-485(Termination Resistor) <p>Serial Port4:</p> <ul style="list-style-type: none"> ▶ Options: Enable and Disable Serial Port (COM) (default) <p>Note: The quantity of serial ports varies according to your model.</p>
Power on after Power fail	<p>Specify what state to go to when power is re-applied after a power failure(G3 state)</p> <ul style="list-style-type: none"> ▶ Options: Always on (default) or Always off.

5.2.7. Hardware Monitor

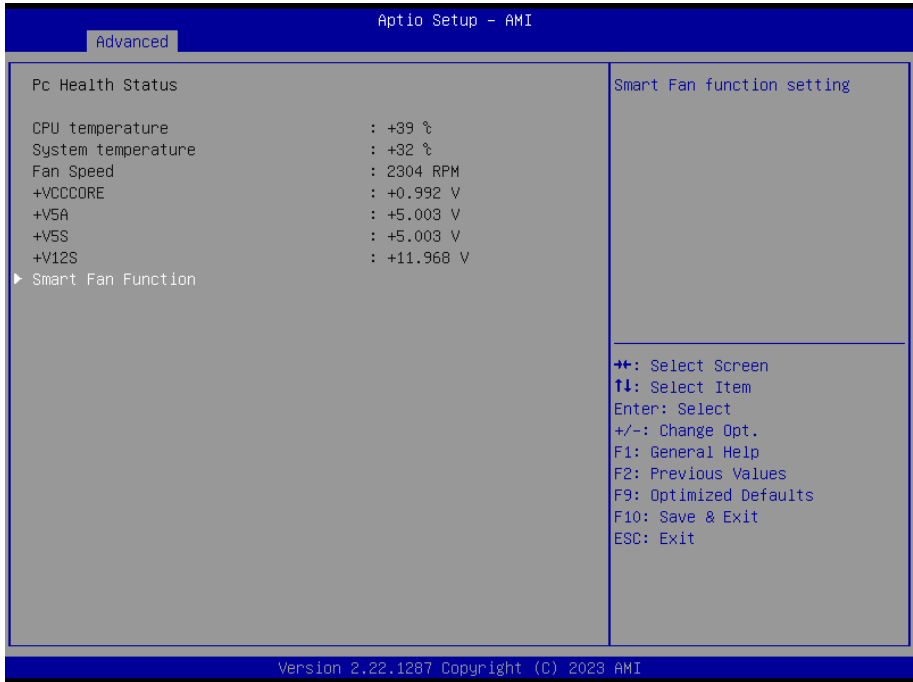

Access this submenu to monitor the hardware status.

Setting	Description
Smart Fan Function	<p>Enable or Disable Fan1 Output Mode Selection.</p> <p>▶ Fan Mode Options available are: Auto - Duty Cycle (default) Manual - Duty Cycle</p>

5.2.8. S5 RTC Wake Settings



Setting	Description
Wake System from S5	<p>Enable or Disable (default) system wake on alarm event.</p> <p>► Options available are: Disabled (default): Fixed Time: System will wake on the hr::min::sec specified. DynamicTime: If selected, you need to set Wake up minute increase from 1 - 5. System will wake on the current time + increase minute(s).</p>

5.2.9. Serial Port Console Redirection

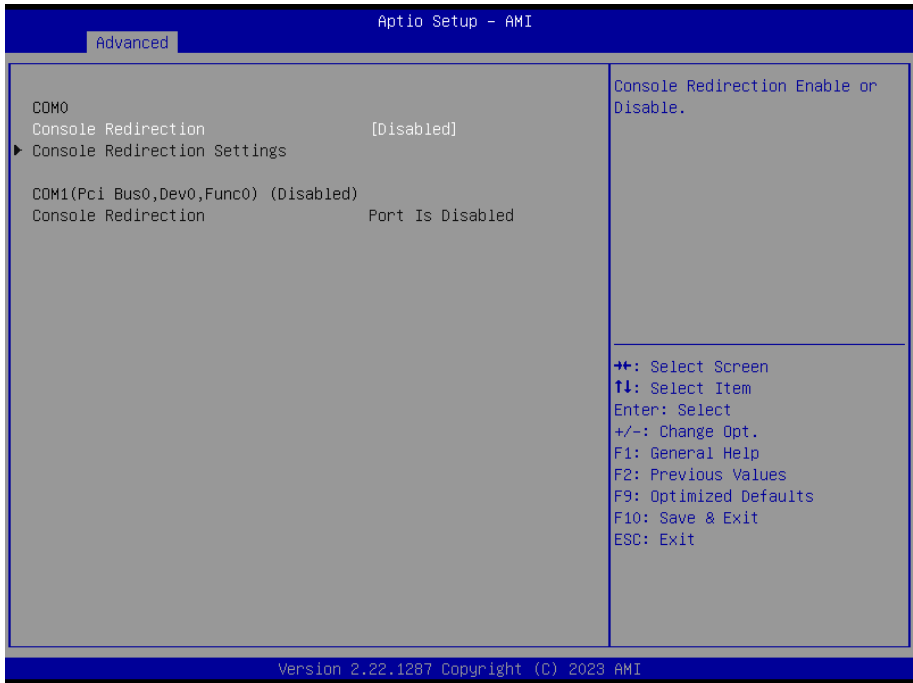

Setting	Description
Console Redirection	Console Redirection Enable or Disable

5.2.10. AMI

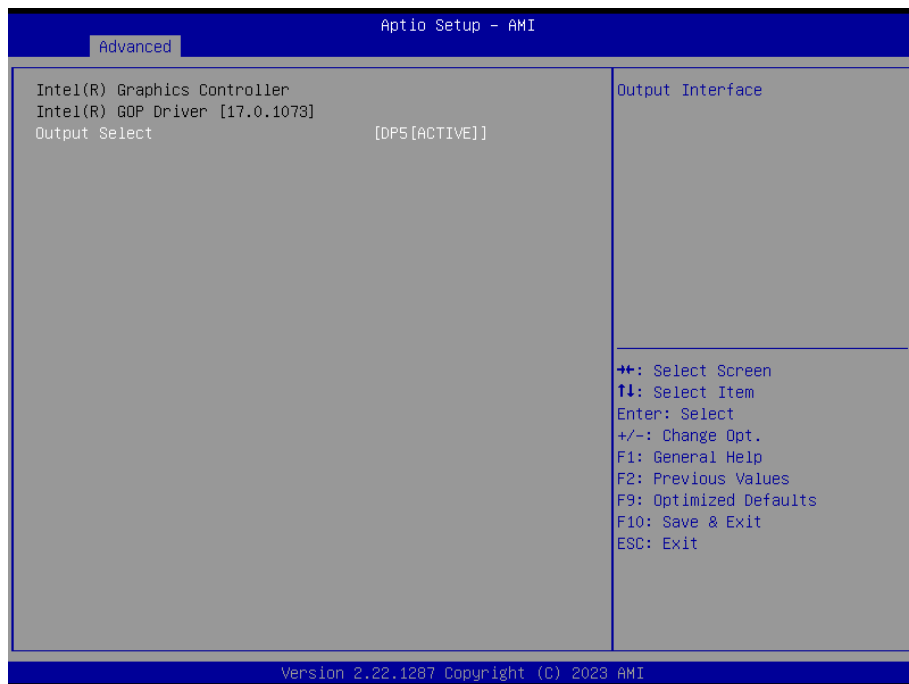

The features settings are:

Setting	Description
Output select	Output Select

5.2.11. USB Configuration

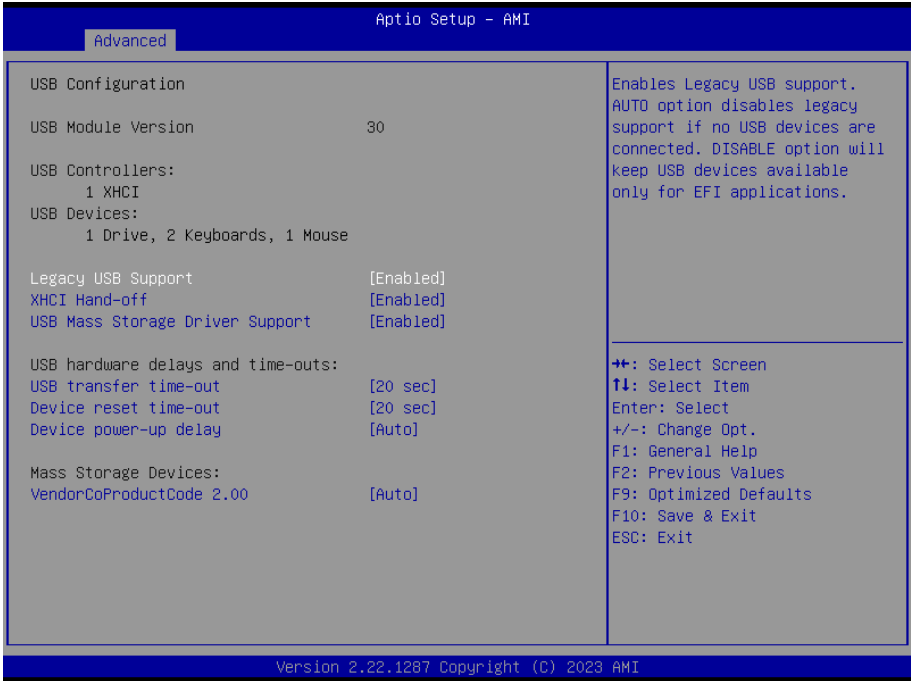

Setting	Description
Legacy USB Support	Enables/disables legacy USB support. <ul style="list-style-type: none"> ▶ Options available are Enabled (default), Disabled and Auto. ▶ Select Auto to disable legacy support if no USB device are connected. ▶ Select Disabled to keep USB devices available only for EFI applications.
XHCI Hand-off	This is a workaround for Oses without XHCI hand-off support. The XHCI ownership change should be claimed by XHCI driver. <ul style="list-style-type: none"> ▶ The optional settings are: Enabled (default) / Disabled.
USB Mass Storage Driver Support	Enables/disables USB Mass Storage Driver Support. <ul style="list-style-type: none"> ▶ The optional settings are: Enabled (default) / Disabled.

USB hardware delay and time-out	
USB transfer time-out	Use this item to set the time-out value for control, bulk, and interrupt transfers. ▶ Options: 1 sec, 5 sec, 10 sec, 20 sec (default)
Device reset time-out	Use this item to set USB mass storage device start unit command time-out. ▶ Options available are: 10 sec, 20 sec (default), 30 sec, 40 sec
Device power-up delay	Use this item to set maximum time the device will take before it properly reports itself to the host controller. 'Auto' uses default value: for a root port it is 100 ms, for a hub port the delay is taken from hub descriptor. ▶ Options available are: Auto: Default Manual: Select Manual you can set value for the following sub-item: 'Device Power-up delay in seconds', the delay range in from 1 to 40 seconds, in one second increments.

5.2.12. Network Stack Configuration

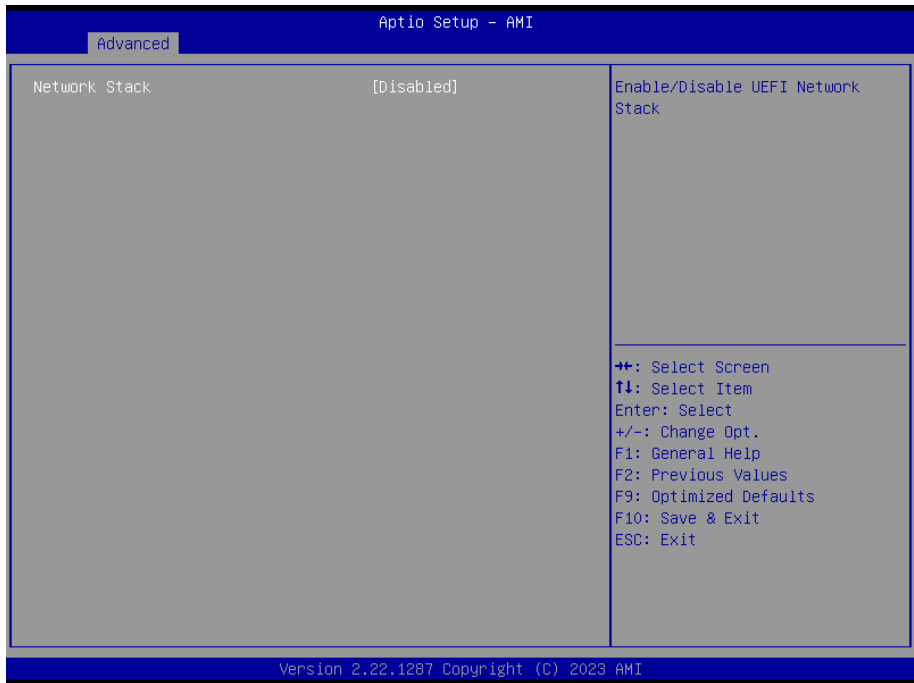

Setting	Description
Network Stack	Enable or Disable (default) UEFI network stack.

5.2.13. NVMe Configuration

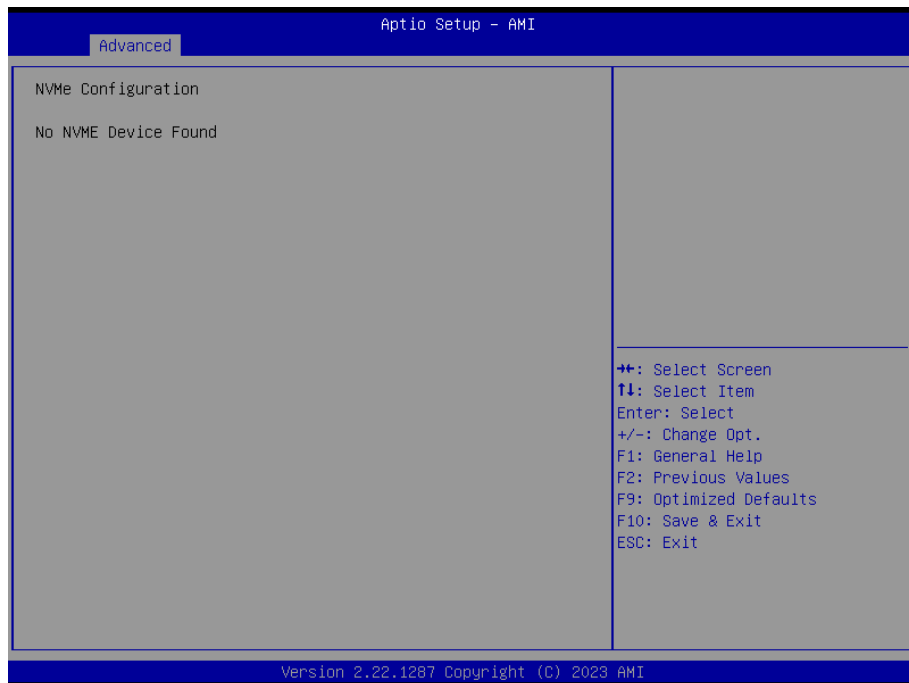

Access this submenu to view the NVMe controller and driver information.

5.3. Chipset



Submenu	Description
System Agent (SA) Configuration	See 5.3.1. System Agent (SA) Configuration on page 65
PCH-IO Configuration	See 5.3.1.3 VMD Configuration on page 68

5.3.1. System Agent (SA) Configuration

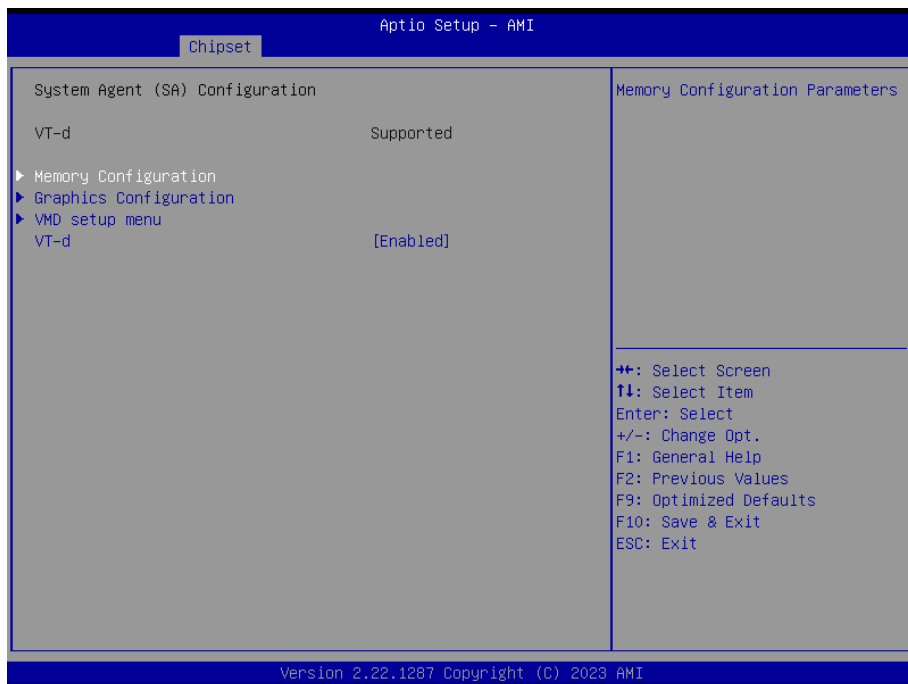

Submenu	Description
System Agent (SA) Configuration	
Memory Configuration	See 5.3.1.1. Memory Configuration on page 66
Graphics Configuration	See 5.3.1.2. Graphics Configuration on page 67
VMD setup menu	Enabled (default) or Disabled to VMD controller
VT-d	Enabled (default) or Disabled VT-d function

5.3.1.1. Memory Configuration

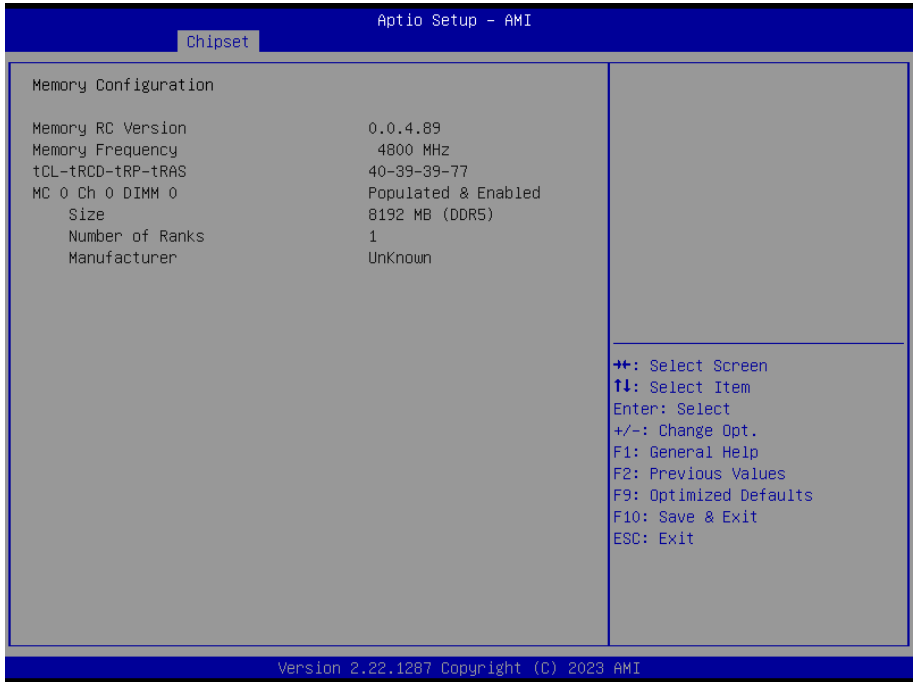

Access this submenu to view the memory configuration.

5.3.1.2. Graphics Configuration

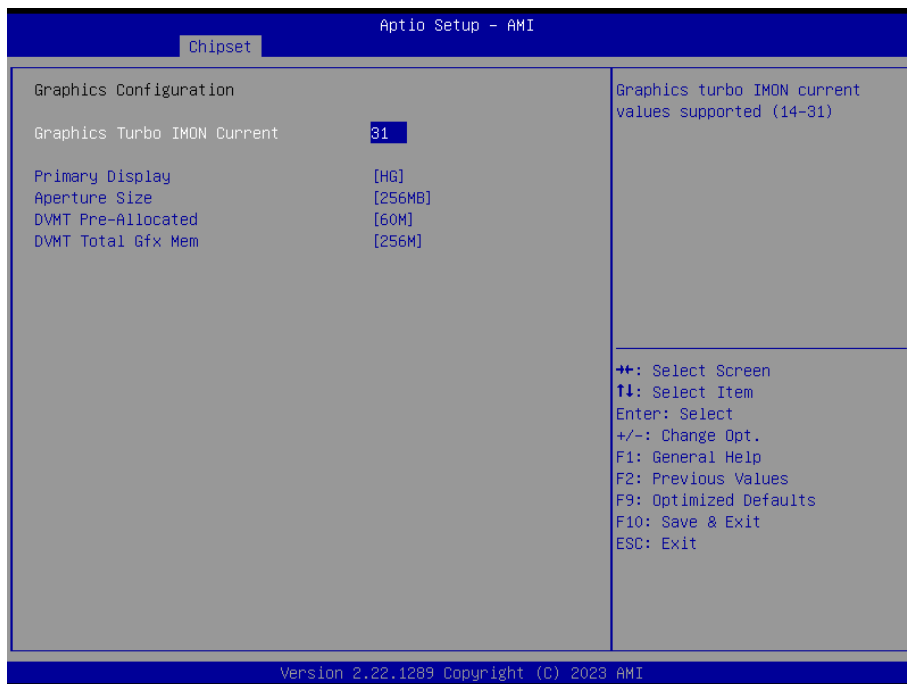

Note: This page varies according to your model.

Setting	Description
Graphics Turbo IMON Current	Graphics turbo IMON current values supported(14-31)
Primary Display	Select which of IGFX/PEG/PCI Graphics device should be Primary Display or select HG for Hybrid GFX. Options: Auto, IGFX, PEG Slot, PCH PCI, HG
Aperture Size	Select the Aperture Size ▶ Options: 128MB, 256MB (default), 512MB and 1024MB .
DVMT Pre-Allocated	Select the DVMT 5.0 Pre-allocated (Fixed) Graphic Memory size used by the Internal Graphic Device. ▶ 60M is the default.
DVMT Total Gfx Mem	Select the DVMT 5.0 Total Graphic Memory size used by the Internal Graphic Device. ▶ Options: 128MB, 256MB (default) and Max .

5.3.1.3 VMD Configuration

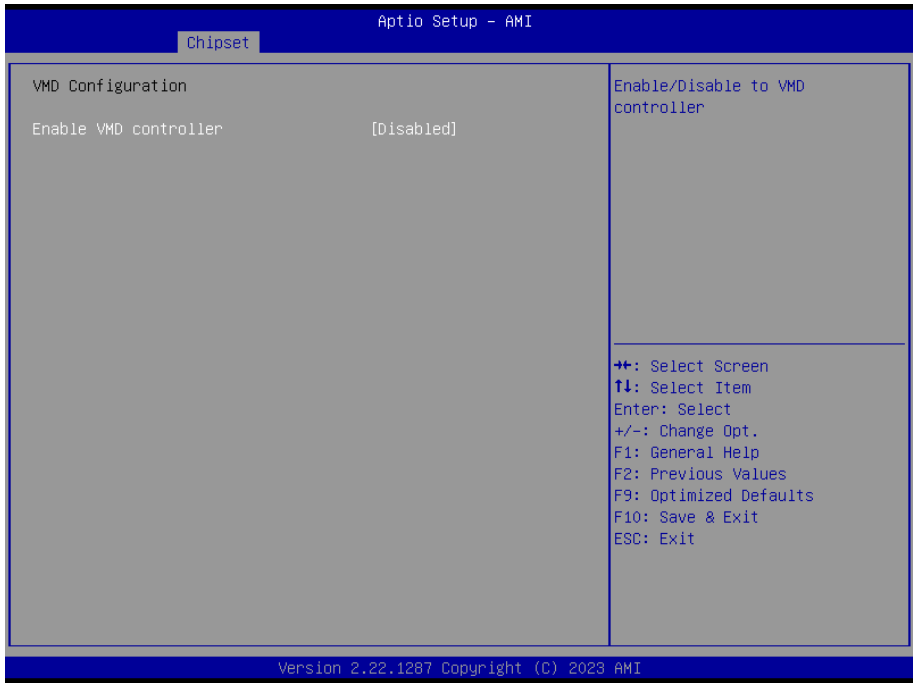

Setting	Description
Enable VMD controller	Enable/Disable to VMD controller ▶ Options: Enabled, Disabled (default).

5.3.1.4 VT-d

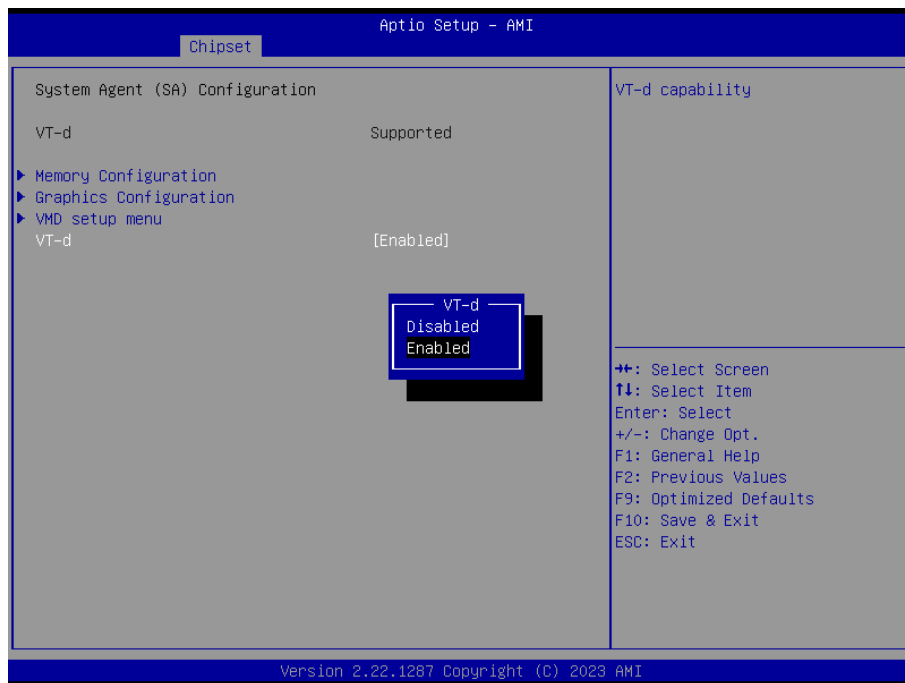

Setting	Description
VT-d	Enable/Disable VT-d capability ▶ Options: Enabled (default), Disabled .

5.3.2. PCH-IO Configuration

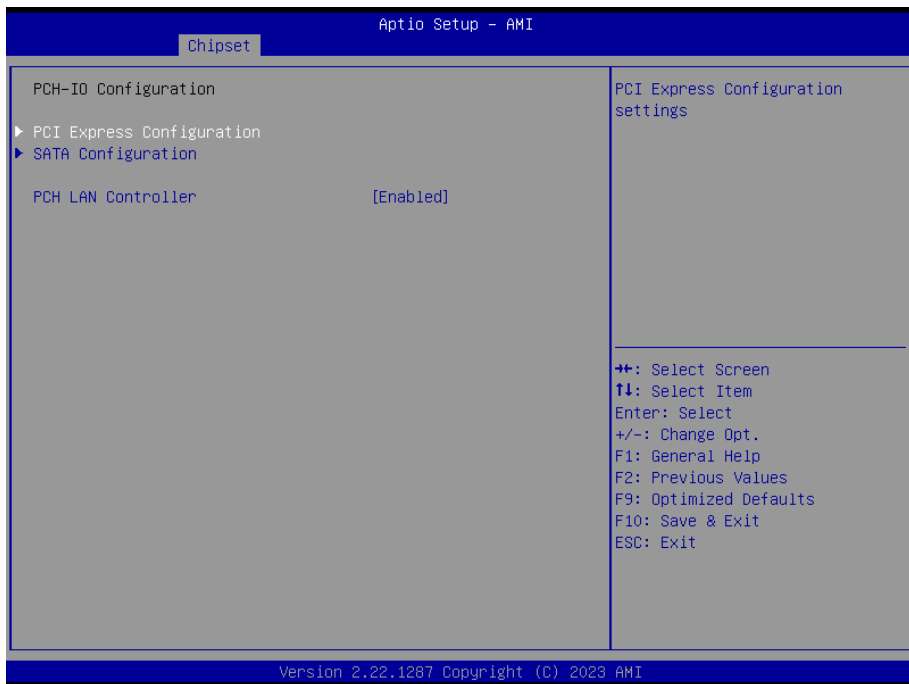

Setting	Description
PCI Express Configuration	See 5.3.2.1. PCI Express Configuration on page 71
SATA Configuration	See 5.3.2.2. SATA Configuration on page 72
PCH LAN Controller	Enable/Disable onboard NIC. ► Options are: Enabled (default), Disabled .

5.3.2.1. PCI Express Configuration

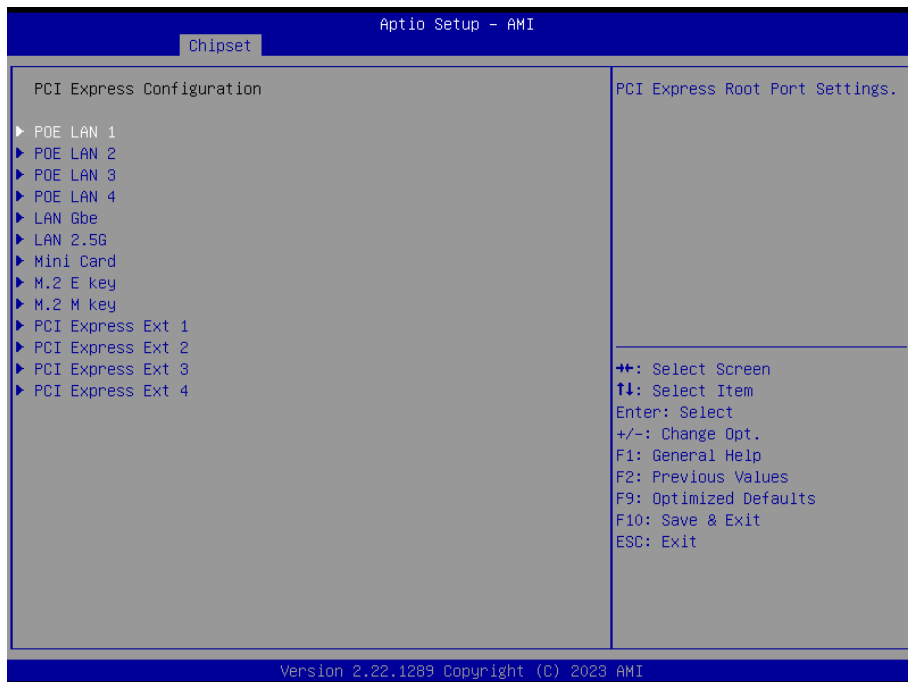

Setting	Description
POE LAN1 - 4	<p>POE LAN 1-4: Control the PCI Express Root Port.</p> <ul style="list-style-type: none"> ▶ Options are: Enabled (default), Disabled. <p>ASPM: Set the ASPM level</p> <ul style="list-style-type: none"> ▶ Options are: Disabled (default), L1, Auto <p>L1 Substates: PCI Express L1 Substates settings.</p> <ul style="list-style-type: none"> ▶ Options are: Disabled (default), L1.1, L1.1 & L1.2 <p>PCIe Speed: Configure PCIe Speed.</p> <ul style="list-style-type: none"> ▶ Options are: Auto (default), Gen1, Gen2, Gen3, Gen4
LAN Gbe	PCI Express root port settings. Control the LAN Gbe root port.
LAN 2.5G	PCI Express root port settings. Control the LAN 2.5G root port.
Mini Card	Configure Mini Card settings.
M.2 E-key	PCI Express root port settings. Control the M.2 E-key root port.
M.2 B-key	PCI Express root port settings. Control the M.2 B-key root port.

5.3.2.2. SATA Configuration

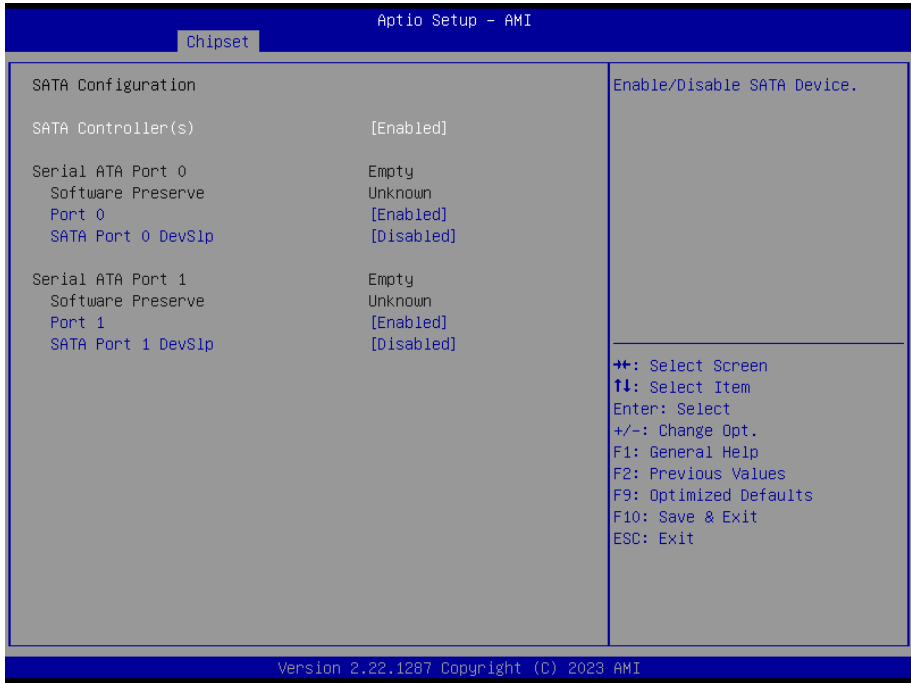

Setting	Description
SATA Controller(s)	Enables (default) / disables SATA device(s).
Serial ATA Port 0/1	SATA device information. *Available SATA ports depend on your device.
Port 0/1	Enables (default) / disables the SATA port.
SATA Port 0/1 DevSlp	Enables / disables (default) the SATA port DevSlp. Board rework for LP needed before enable.

5.4. Security



Setting	Description
Administrator Password	To set up an administrator password: <ol style="list-style-type: none"> 1. Select Administrator Password. 2. An Create New Password dialog then pops up onscreen. 3. Enter your desired password that is no less than 3 characters and no more than 20 characters. 4. Hit [Enter] key to submit.
Security Boot	See 5.4.1 Security Boot on page 74

5.4.1 Security Boot



Setting	Description
Secure Boot	Enabled/Disabled (default) secure boot.
Secure Boot Mode	Allow users to set the secure boot selector. Options are: Standard/Custome (default) mode.
Restore Factory Keys	Force system to restore default secure boot key database.
Reset to Setup Mode	Delete all secure boot key databases.
Key Management	Allow users to modify secure variables and set key management page.

5.5. Boot

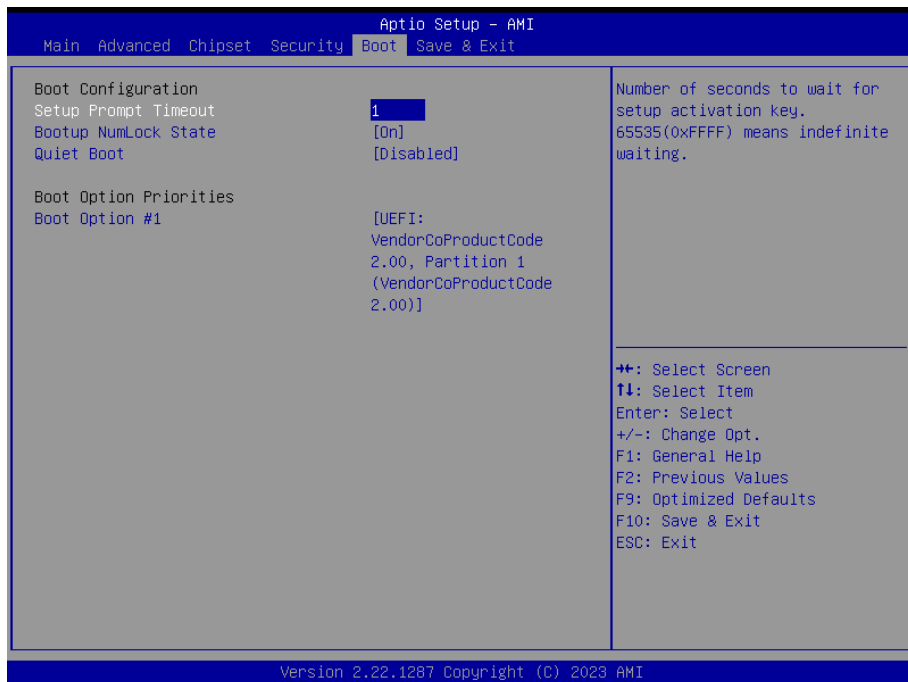

Setting	Description
Setup Prompt Timeout	Set how long to wait for the prompt to show for entering BIOS Setup. <ul style="list-style-type: none"> ▶ The default setting is 1 (sec). ▶ Set it to 65535 to wait indefinitely.
Bootup NumLock State	Sets whether to enable or disable the keyboard's NumLock state when the system starts up. <ul style="list-style-type: none"> ▶ Options available are On (default) and Off.
Quiet Boot	Sets whether to display the POST (Power-on Self Tests) messages or the system manufacturer's full screen logo during booting. <ul style="list-style-type: none"> ▶ Select Disabled to display the normal POST message, which is the default.
Boot Option Priority	Set the system boot priorities.

5.6. Save & Exit

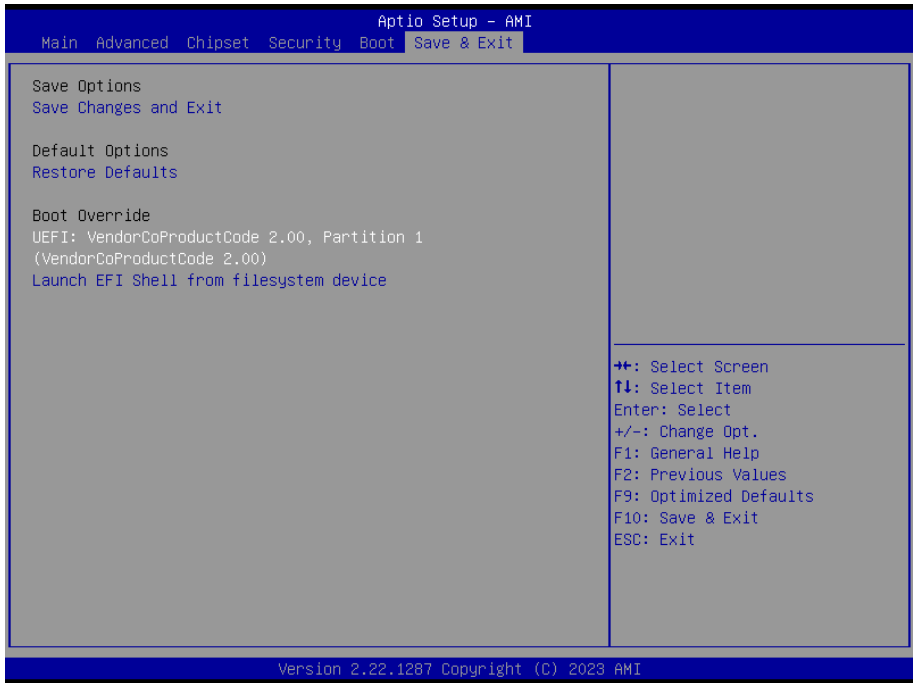

Setting	Description
Save Changes and Exit	Saves the changes and quits the BIOS Setup utility.
Restore Defaults	Restores all settings to defaults. <ul style="list-style-type: none"> ▶ This is a command to launch an action from the BIOS Setup utility.
Boot Override	Boot Override presents a list in context with the boot devices in the system. <ul style="list-style-type: none"> ▶ P0: Select the device to boot up the system regardless of the currently configured boot priority. ▶ Launch EFI Shell from filesystem device: Attempts to launch EFI Shell Application (Shell.efi) from one of the available filesystem devices.

Appendix

Appendix A. 16-bit Opto-Isolated DI Signal Connections

A.1. Wet Contact DI with NPN / PNP connection

Digital Input - Wet Contact	
V_{off}	V_{on}
Max. 3V	12~24V

PNP

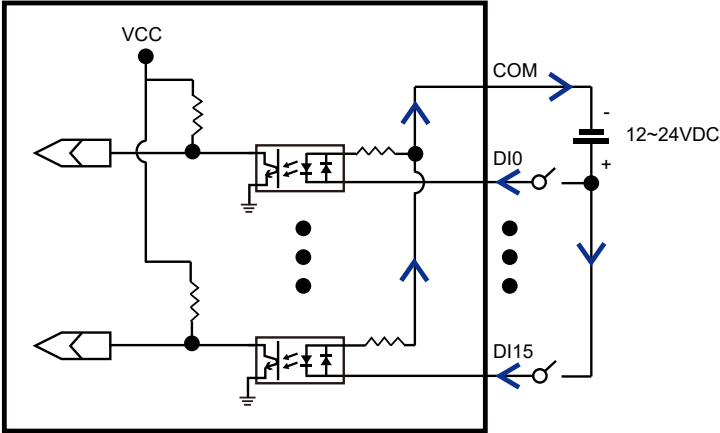

NPN

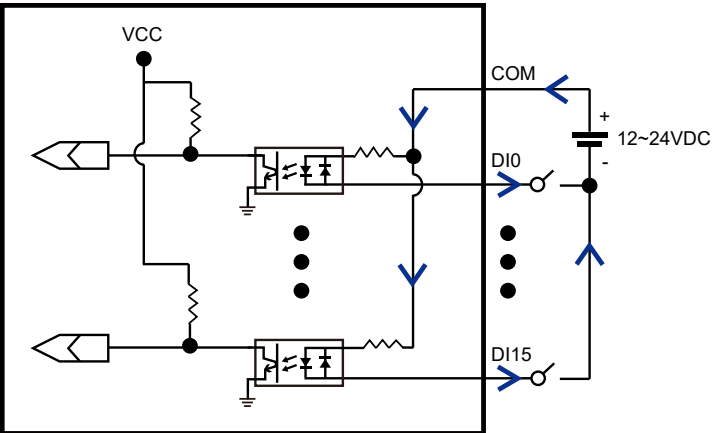

A.2. Dry Contact DI with NPN / PNP connection

PNP

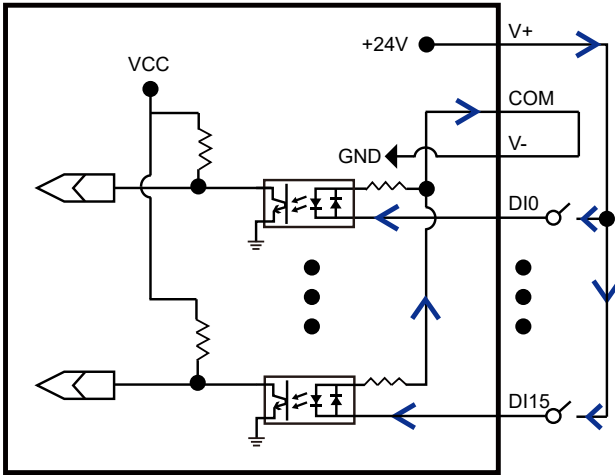

NPN

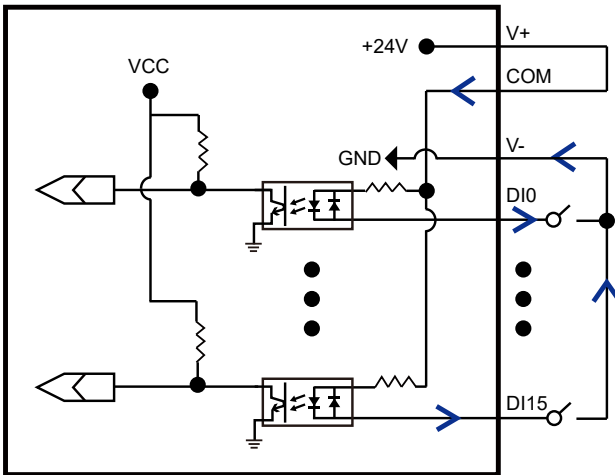

Appendix B. 16-bit Opto-Isolated DO Signal Connections

B.1. DO Connection diagram

When an isolated output channel is being used as an output channel, if an external voltage (maximum 24V) is applied, the current will flow from the external voltage source to the system. Make sure that the current through each out pin does not exceed 100 mA.

